

HAM-LET HOSES

METAL | PTFE | RUBBER | NYLON
& COMPONENTS



INDEX

HOSES ASSEMBLIES

HAM-LET METAL HOSES	17
HAM-LET PTFE HOSES.....	31
HAM-LET RUBBER HOSES.....	39
HAM-LET NYLON HOSES.....	43

HOSES COMPONENTS

METAL HOSES.....	47
PTFE HOSES.....	57
RUBBER HOSES.....	67

STANDARD PTFE HOSES

PTFE HOSES.....	72
-----------------	----

HOSES END CONNECTIONS



LET-LOK®



ONE-LOK®

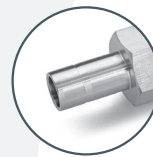

Tube Adapter

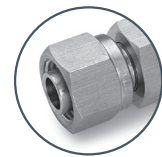

Pre Swaged
Tube Adapter



Male NPT



Female NPT



Male BSPP



Female BSPP



Male Face
Seal Swivel



Female Face
Seal Swivel

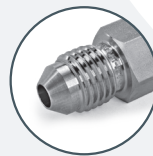

Male
JIC 37° Flare



Female
JIC 37° Flare

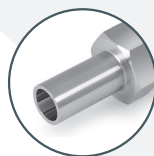

Butt Weld



UH Line

METAL HOSES



SHF SERIES 21
General Use



SHE SERIES 22
Extra Flexible



SHJ SERIES 23
High Pressure Flexible



SHU SERIES 24
Ultra High Pressure



SHV SERIES 25
Formable



AHF SERIES 26
C-276



SHP SERIES 27
Industrial Gas Application



COMPONENTS 47

PTFE HOSES



THT SERIES 33
Smooth Core



THS SERIES 33
Silicone Covered Smooth
Core General Use



THC SERIES 34
Convuluted Core



THB SERIES 34
Smooth Core
Fiber Braid



THR SERIES 35
Smooth Core
With Additional Fiber Braid



THQ SERIES 36
Multiple Braided and
Silicone Covered Smooth
Core



THV SERIES 36
Multiple Layered
Conductive PTFE Core



COMPONENTS 59

RUBBER HOSES



RHG SERIES 40
General Use



COMPONENTS 67

NYLON HOSES



NHG SERIES 44
Nylon Reinforced

Hoses Quick Selection Guide

Inside Diameter inch (mm)																	
Hose Series	Number of Braids	1/4 (6.35)		3/8 (9.53)		1/2 (12.70)		3/4 (19.05)		1 (25.40)		1 1/4 (31.75)		1 1/2 (38.10)		2 (50.80)	
		Working Pressure psi (bar)	Dynamic Bend Radius inch (mm)	Working Pressure psi (bar)	Dynamic Bend Radius inch (mm)	Working Pressure psi (bar)	Dynamic Bend Radius inch (mm)	Working Pressure psi (bar)	Dynamic Bend Radius inch (mm)	Working Pressure psi (bar)	Dynamic Bend Radius inch (mm)	Working Pressure psi (bar)	Dynamic Bend Radius inch (mm)	Working Pressure psi (bar)	Dynamic Bend Radius inch (mm)	Working Pressure psi (bar)	Dynamic Bend Radius inch (mm)
SHF General use Standard Metal Hose T321, T316L, T304L See page 21	0	90 (6)		70 (5)		70 (5)		43 (3)		43 (3)		43 (3)		28 (2)		14 (1)	
	1	1800 (124)	4.5 (114)	1558 (107)	5.0 (127)	1186 (82)	5.5 (140)	898 (62)	8.0 (203)	718 (50)	9.0 (229)	645 (44)	10.0 (254)	531 (37)	11.0 (279)	449 (31)	13.0 (330)
	2	2700 (186)		2336 (161)		1779 (123)		1347 (93)		1077 (74)		968 (67)		797 (55)		674 (46)	
SHE Extra Flexible Most Flexible Hose T321, T316L, T304L See page 22	0	90 (6)		70 (5)		70 (5)		43 (3)		43 (3)		43 (3)		28 (2)		14 (1)	
	1	1800 (124)	3.7(94)	1558 (107)	4.0 (102)	1186 (82)	4.4 (112)	898 (62)	6.4 (163)	718 (50)	7.1 (180)	645 (44)	7.9 (201)	531 (37)	8.7 (221)	449 (31)	10.3 (262)
	2	2700 (186)		2336 (161)		1779 (123)		1347 (93)		1077 (74)		968 (67)		797 (55)		674 (46)	
SHJ Over Flexible Higher-Pressure More Flexible T321, T316L, T304L See page 23	0	450 (31)		400 (28)		400 (28)		220 (15)		190 (13)		200 (14)		90 (6)		105 (7)	
	1	3000 (207)	5.5 (140)	2400 (165)	8.5 (215)	2400 (165)	10.0 (254)	1100 (76)	8.0 (203)	1000 (69)	9.0 (229)	900 (62)	12.0 (305)	750 (52)	13.0 (330)	800 (55)	15.0 (381)
	2	4000 (276)		3300 (226)		3200 (221)		1650 (114)		1400 (97)		1350 (93)		1200 (83)		1150 (79)	
SHU Ultra High Pressure Higher Pressure T321 & T316L See page 24	0	500 (34)		400 (25)		200 (14)		250 (17)	4.5 (114)	180 (12)	7.0 (178)	190 (13)	9.5 (241)	110 (8)	11.5 (292)	100 (7)	12.0 (305)
	1	5000 (345)	4.5 (114)	3500 (241)	7.0 (177)	2700 (186)	8.5 (203)	2650 (182)	10.0 (254)	2500 (172)	11.0 (279)	1775 (122)	12.5 (318)	1450 (100)	13.0 (330)	1100 (76)	14.0 (356)
	2	6000 (414)		5000 (344)		4500 (310)		3600 (248)	10.0 (254)	3000 (207)	11.0 (279)	2600 (179)	12.5 (318)	2200 (152)	13.0 (330)	1675 (115)	14.0 (356)
	3	-		-		-		-	-	-	-	3000 (207)	14.0 (356)	-	-	-	-
SHV Formable Stay-Put Application T321, T316L See page 25	0	90 (6)		70 (5)		70 (5)		43 (3)		43 (3)		43 (3)		28 (2)		14 (1)	
	1	900 (62)	-	800 (55)	-	665 (46)	-	380 (26)	-	355 (24)	-	280 (19)	-	264 (18)	-	221 (15)	-
AHF C-276 See page 26	0	-		-		70 (5)		43 (3)		43 (3)		-		-		-	
	1	-	-	-	-	1186 (82)	5.5 (140)	898 (62)	8.0 (203)	718 (50)	9.0 (229)	-	-	-	-	-	-
	2	-		-		1779 (123)		1347 (93)		1077 (74)		-		-		-	
SHP Industrial Gas Application T316L See page 27	1	2610 (180)		2102 (145)		2030 (140)		1232 (85)		1131 (78)	8.46 (215)	942 (65)		884 (61)	11.02 (280)	797 (55)	
	2	3697 (255)	4.33 (110)	3233.5 (195)	5.91 (150)	2682 (185)	6.50 (165)	1812 (125)	8.86 (225)	1798 (124)	10.24 (260)	1667 (115)	11.81 (300)	1305 (90)	13.39 (340)	1131 (78)	15.35 (390)

* Inside diameter for these hose parameters is 16mm

Hoses Quick Selection Guide (cont.)

Inside Diameter inch (mm)																	
Hose Series	Number of Braids	1/8 (6.35)		1/4 (6.35)		3/8 (9.53)		1/2 (12.70)		3/4 (19.05)		1 (25.40)		1 1/2 (38.10)		2 (50.80)	
		Working Pressure psi (bar)	Dynamic Bend Radius inch (mm)	Working Pressure psi (bar)	Dynamic Bend Radius inch (mm)	Working Pressure psi (bar)	Dynamic Bend Radius inch (mm)	Working Pressure psi (bar)	Dynamic Bend Radius inch (mm)	Working Pressure psi (bar)	Dynamic Bend Radius inch (mm)	Working Pressure psi (bar)	Dynamic Bend Radius inch (mm)	Working Pressure psi (bar)	Dynamic Bend Radius inch (mm)	Working Pressure psi (bar)	Dynamic Bend Radius inch (mm)
PTFE HOSES																	
THT Smooth Core See page 33	1	3000 (207)	1.5 (38)	2600 (180)	3.0 (76)	2300 (156)	5.0 (127)	1500 (103)	6.5 (165)	1100 (76)	9.0 (229)	900 (62)	12.0 (305)	-	-	-	-
THS Silicone Covered Smooth Core See page 33	1	3000 (207)	1.5 (38)	3000 (207)	3.0 (76)	2300 (156)	5.0 (127)	1500 (103)	6.5 (165)	1100 (76)	9.0 (229)	1000 (69)	12.0 (305)	-	-	-	-
THC Convuluted Core See page 34	1	-	-	2500 (172)	0.7 (18)	2000 (136)	0.8 (20)	1500 (103)	1.0 (25)	1000 (69)	2.5 (64)	670 (45)	3.5 (89)	440 (30)	6.0 (152)	330 (23)	7.9 (200)
THB Fiberglass Braid See page 34	1	-	-	800 (55)	2.8 (70)	800 (55)	3.3 (83)	800 (55)	5.3 (133)	400 (27)	6.5 (165)	-	-	-	-	-	-
THR Fiberglass Braid + SS See page 35	1	-	-	3500 (241)	1.0 (26)	3000 (207)	1.6 (40)	1800 (124)	2.5 (64)	1000 (69)	4.3 (108)	-	-	-	-	-	-
THQ Silicone Covered Smooth PTFE Core Fiberglass Middle Layer SS Braided Hose-Page 36	1	-	-	3500 (241)	1.75 (44.45)	3000 (207)	1.6 (40)	1800 (124)	2.6 (64)	1400 (97)	7 (177.8)	-	-	-	-	-	-
THV Silicone Covered Smooth Carbon PTFE Core Fiberglass middle insulating layer ceramic wrap ss braided hose- page 36	1	-	-	-	-	750 (51.72)	0.79 (19.99)	750 (51.72)	0.96 (24.38)	500 (34.48)	1.27 (32.13)	-	-	-	-	-	-
NYLON HOSES																	
NHG CNG Gas Application See Page 44	-	5000 (345)	1.8 (45)	5000 (345)	3.0 (75)	5000 (345)	3.7 (95)	5000 (345)	7.3 (185)	5000 (345)	9.1 (230)	5000 (345)	-	-	-	-	-
RUBBER HOSES																	
RHG Designed to use with HAM-LET HOSE END™ See page 40	1	300 (20.7)	2.6 (65)	300 (20.7)	3.0 (75)	300 (20.7)	5.1 (130)	300 (20.7)	7.1 (180)	300 (20.7)	8.0 (203)	300 (20.7)	-	-	-	-	-

Hoses End Connections Selection

End Connection Type	End Connection Size	Metal Hoses - Series SHF / SHU / SHV / SHE / SHP / SHJ								PTFE Hoses - Series THT / THS / THC / THB / THR / THQ / THV (○), Rubber Hose RHG (◇), Nylon Hose NHG (□) I.D. inch (mm)							
		I.D. inch (mm)								I.D. inch (mm)							
		1/4 (6.35)	3/8 (9.53)	1/2 (12.70)	3/4 (19.05)	1 (25.40)	1 1/4 (31.75)	1 1/2 (38.10)	2 (50.80)	1/8 (3.18)	1/4 (6.35)	3/8 (9.53)	1/2 (12.70)	3/4 (19.05)	1 (25.40)	1 1/2 (38.10)	2 (50.80)
LET-LOK®	1/8"									○							
	1/4"	○	○								○◇□						
	3/8"	○	○	○								○◇□					
	1/2"	○		○	○	○							○◇□				
	3/4"				○	○							○	○◇□			
	1"				○	○									○◇□		
	1 1/4"							○									
	1 1/2"								○							○	
	2"									○							○
	3mm									○							
	6mm	○	○							○	○◇□						
	8mm	○									○◇□	○					
	10mm		○				○					○◇□					
	12mm	○	○	○	○	○						○	○◇□				
	16mm		○			○											
	18mm					○								○◇□			
25mm					○	○								○◇□			
38mm								○							○		
Tube Adapter (11/4-2 are preswaged)	1/8"									○							
	1/4"	○	○	○						○	○◇□	◇					
	3/8"	○	○	○							○◇	○◇□	○◇				
	1/2"		○	○	○						○◇	○◇	○◇□	◇			
	3/4"			○	○	○							○◇	○◇□	○◇		
	1"				○	○							○	○◇	○◇□		
	1 1/4"							○									
	1 1/2"								○							○	
	2"									○							○
	3mm									○							
	6mm	○	○							○	○◇□				○		
	8mm	○	○	○							○◇□	◇					
	10mm	○	○	○								○◇□					
	12mm			○								◇	○◇□				
	16mm			○		○							○	○◇□			
	18mm					○							○	○◇□			
25mm						○								○◇□			
38mm								○							○		
50mm									○							○	
ONE-LOK®	1/4"	○	○								○◇□						
	3/8"	○	○	○								○◇□					
	1/2"	○		○	○	○							○◇□				
	6mm	○									○◇□						
	8mm	○									○◇□	○					
	12mm		○	○	○	○						○◇□					
UH Line (for vacuum only)	1/4"	○															
	3/8"	○	○														
	1/2"			○													
	3/4"				○												
	1"					○											

Hoses End Connections Selection





End Connection Type	End Connection Size	Metal Hoses - Series SHF / SHU / SHV / SHE / SHP / SHJ								PTFE Hoses - Series THT / THS / THC / THB / THR / THQ / THV (○), Rubber Hose RHG (◇), Nylon Hose NHG (□)								
		I.D. inch (mm)																
		1/4 (6.35)	3/8 (9.53)	1/2 (12.70)	3/4 (19.05)	1 (25.40)	1 1/4 (31.75)	1 1/2 (38.10)	2 (50.80)	1/8 (3.18)	1/4 (6.35)	3/8 (9.53)	1/2 (12.70)	3/4 (19.05)	1 (25.40)	1 1/2 (38.10)	2 (50.80)	
Male NPT	1/8"									○								
	1/4"	○	○	○				○			○◇□	○◇	○					
	3/8"	○	○	○							○◇	○◇□	○◇□					
	1/2"	○	○	○	○							○◇	○◇□	○◇				
	3/4"				○	○							◇	○◇□	○			
	1"				○	○		○							○◇□			
	1 1/4"							○										
	1 1/2"								○								○	
2"									○								○	
Female NPT	1/8"									○								
	1/4"	○									○◇□	○						
	3/8"	○	○									○◇□						
	1/2"	○		○	○								○◇□					
	3/4"			○	○									○◇□				
	1"					○									○◇□			
	1 1/4"							○								○		
	1 1/2"																○	
2"																	○	
Male BSPP	1/8"									○	○							
	1/4"	○									○◇□							
	3/8"		○	○							○	○◇□						
	1/2"			○									○◇□					
	3/4"			○	○									○◇□				
	1"					○									○◇□			
	1 1/4"							○										
	1 1/2"								○								○	
Female BSPP	1/8"									○	○◇							
	1/4"	○									○◇□							
	3/8"		○									○◇□						
	1/2"	○		○									○◇□					
	3/4"				○									○◇□				
	1"														○◇□			
	1 1/4"							○										
	1 1/2"															○		
2"																	○	
Butt Weld Adapter	1/4"	○	○	○							○◇□							
	3/8"	○	○									○◇□						
	1/2"	○		○									○◇□					
	3/4"				○	○								○◇□	○			
	1"				○	○		○							○◇□			
	1 1/4"							○										
	1 1/2"								○								○	
	2"																	○
Male Face Seal Swivel	1/4"	○									○◇□							
	3/8"				○													
	1/2"	○	○	○									○◇□					
	3/4"				○									○◇□				
	1"					○									○◇□			

Hoses End Connections Selection





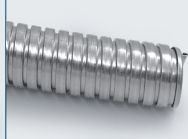
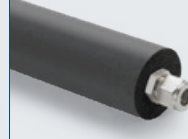

End Connection Type	End Connection Size	Metal Hoses - Series SHF / SHU / SHV / SHE / SHP / SHJ /								PTFE Hoses - Series THT / THS / THC / THB / THR / THQ / THV (○), Rubber Hose RHG (◇), Nylon Hose NHG (□)							
		I.D. inch (mm)															
		1/4 (6.35)	3/8 (9.53)	1/2 (12.70)	3/4 (19.05)	1 (25.40)	1 1/4 (31.75)	1 1/2 (38.10)	2 (50.80)	1/8 (3.18)	1/4 (6.35)	3/8 (9.53)	1/2 (12.70)	3/4 (19.05)	1 (25.40)	1 1/2 (38.10)	2 (50.80)
Male Face Seal Swivel	1/4"	○									○◇□						
	1/2"	○	○	○								○◇□					
	3/4"				○								○◇□				
	1"					○		○						○◇□			
Male JIC 37° Flare	1/8"									○							
	1/4"	○									○◇□						
	3/8"		○									○◇□					
	1/2"			○								○◇□					
	3/4"				○								○◇□				
	1"					○								○◇□			
	1 1/4"							○									
	1 1/2"								○								
Female JIC 37° Flare	1/4"	○															
	3/8"		○									○◇□					
	1/2"			○								○◇□					
	3/4"				○								○◇□				
	1"					○								○◇□			
Male BSP-T	1/8"										○						
	1/4"	○										○◇					
	3/8"		○										○◇				
	1/2"			○									○◇				
	3/4"				○									○◇			
	1"					○									○◇		
	1 1/4"							○									
	1 1/2"								○							○◇	
Female BSP-T	1/8"										○						
	1/4"	○										○◇					
	3/8"		○										○◇				
	1/2"			○									○◇				
	3/4"				○									○◇			
	1"					○									○◇		
	1 1/4"																
	1 1/2"								○							○◇	

End Connection Type	End Connection Size	Metal Hoses - Series SHF / SHU / SHV / SHE / SHP / SHJ								PTFE Hoses - Series THT / THS / THC / THB / THR / THQ / THV (○), Rubber Hose RHG (◇), Nylon Hose NHG (□)							
		I.D. inch (mm)															
		1/4 (6.35)	3/8 (9.53)	1/2 (12.70)	3/4 (19.05)	1 (25.40)	1 1/4 (31.75)	1 1/2 (38.10)	2 (50.80)	1/8 (3.18)	1/4 (6.35)	3/8 (9.53)	1/2 (12.70)	3/4 (19.05)	1 (25.40)	1 1/2 (38.10)	2 (50.80)
Tube Adapter Pre-Swaged	1/8"									○							
	1/4"	○	○	○						○	○◇□	◇					
	3/8"	○	○	○							○◇	○◇□	○◇				
	1/2"		○	○	○						○◇	○◇	○◇□	◇			
	3/4"			○	○	○							○◇	○◇□	○◇		
	1"				○	○							○	○◇	○◇□		
	1 1/4"						○										
	1 1/2"							○								○	
	2"								○								○
	3mm									○							
	6mm	○	○							○	○◇□			○			
	8mm	○	○	○							○◇□	◇					
	10mm	○	○	○								○◇□					
	12mm			○								◇	○◇□				
	16mm			○		○											
	18mm				○								○	○◇□			
	25mm					○									○◇□		
38mm							○								○		
50mm								○								○	

Hose Options

		OUTER COVER				INTERNAL LINER
						
		R Protective Cover	J Fire Jacket	A Armor	K Thermal Insulation Cover	L Liner
Metal	SHF	✓	✓	✓	✓	✓
	SHE	✓	✓	✓	✓	✓
	SHJ	✓	✓	✓	✓	✓
	SHU	✓	✓	✓	✓	✓
	SHV	✓	✓	✓	✓	✓
	AHF	✓	✓	✓	✓	✓
	SHP	✓	✓	NA	✓	NA
PTFE	THT	✓	✓	NA	✓	NA
	THS	✓	✓	NA	✓	NA
	THC	✓	✓	NA	✓	NA
	THB	✓	✓	NA	✓	NA
	THR	✓	✓	NA	✓	NA
	THQ	✓	✓	NA	✓	NA
	THV	✓	✓	NA	✓	NA
Rubber	RHG	✓	✓	NA	✓	NA

Hose Options

		TAGGING				TEST	CLEANING
							
		P Plastic Tag	M Metal Tag (standard for metal hoses)	B Both Ends	Z Standard information etched on collar	H Helium Leak Test 1x10 ⁻⁹ Std. CC/Sec	O Oxygen Cleaning
Metal	SHF	✓	✓	✓	✓	✓	✓
	SHE	✓	✓	✓	✓	✓	✓
	SHJ	✓	✓	✓	✓	✓	✓
	SHU	✓	✓	✓	✓	✓	✓
	SHV	✓	✓	✓	✓	✓	✓
	AHF	✓	✓	✓	✓	✓	✓
	SHP	✓	✓	NA	NA	NA	NA
PTFE	THT	✓	✓	✓	NA	NA	NA
	THS	✓	✓	✓	NA	NA	NA
	THC	✓	✓	✓	NA	NA	NA
	THB	✓	✓	✓	NA	NA	NA
	THR	✓	✓	✓	NA	NA	NA
	THQ	✓	✓	✓	NA	NA	NA
	THV	✓	✓	✓	NA	NA	NA
Rubber	RHG	✓	✓	✓	NA	NA	NA

Selecting & Installing Hose Assemblies

Length Considerations

To calculate the proper length of a hose assembly, please complete the following steps:

1. Verify that the installation is properly designed (see Do's & Don'ts herein)
 - Do not torque the hose
 - Do not over bend the hose
 - Do not compress the hose
2. Calculate the live length of the assembly - The live length of the assembly is the amount of active (flexible) hose in an assembly; that is, the hose between the braid collars (see formulas to help calculate live length for a variety of common hose installations herein).
3. Calculate the overall length of the assembly - Overall length is equal to the live length plus the lengths of the braid collars and fittings. When adding fitting lengths, be aware that the points from which measurements should be taken vary for different fitting types. When calculating overall length for assemblies with threaded fittings, remember to account for the length of thread that is lost by threading into the mating connection (refer to Thread Allowance chart herein).

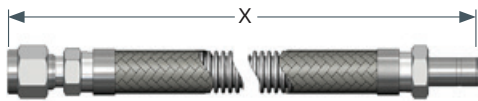

Compression fittings are measured to the end of the fitting

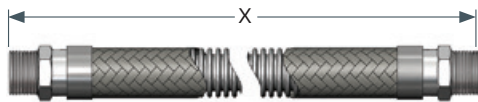

Threaded fittings are measured to the end of the fitting

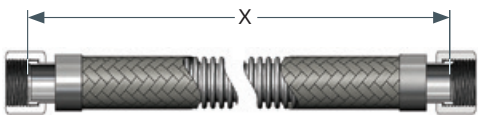

JIC/SAE-type fittings are measured from the seat of the fitting

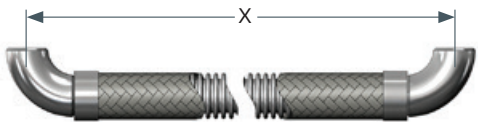

Elbows and other fittings with a radius are measured from the centerline of the fitting

Hose Assembly

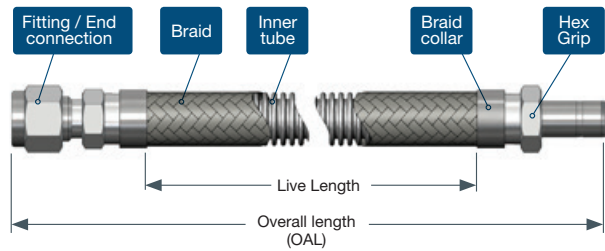

Thread Allowance

When calculating the overall length (OAL) of a hose assembly that has a pipe thread as one or both end connection(s), thread engagement should be considered.



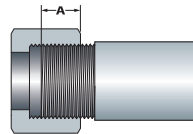

Example: using the chart below, a hose assembly with a 1" male pipe on one end would have 0.66" added to the OAL to compensate for the length of thread that will be engaged during installation.

Nominal Pipe Size inch	1/4	3/8	1/2	3/4	1	1 1/4	1 1/2	2
Thread Allowance inch (mm) -Dim "A"	0.40 (10)	0.41 (10)	0.53 (13)	0.55 (14)	0.66 (17)	0.68 (17)	0.68 (17)	0.70 (18)

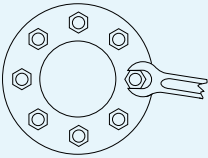
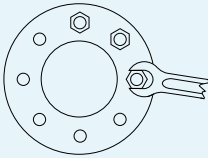
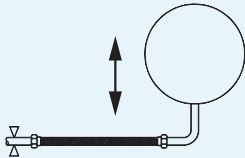
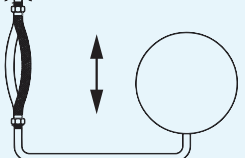
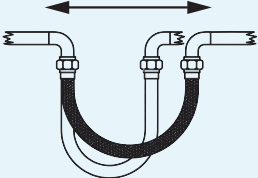

Selecting & Installing Hose Assemblies

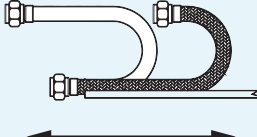
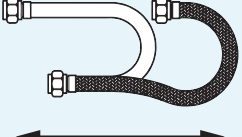
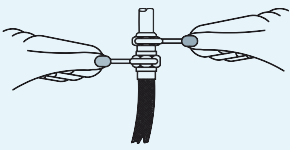
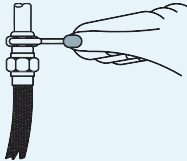
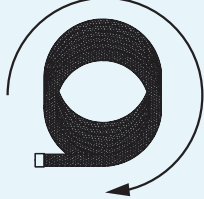
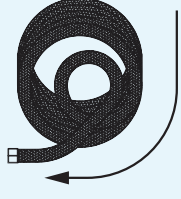
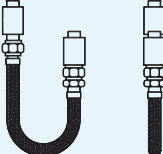
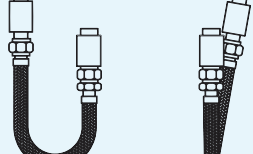
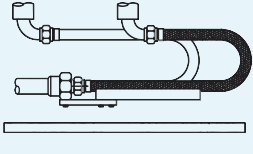
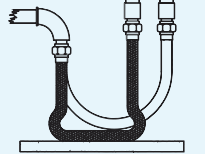
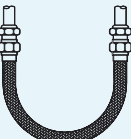
Installation Do's & Don'ts

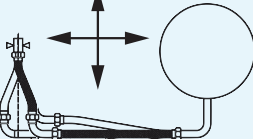
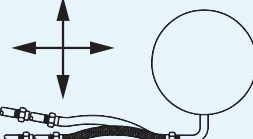
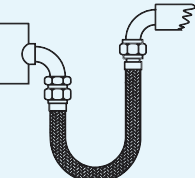
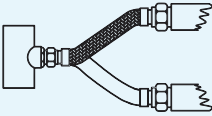
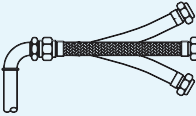
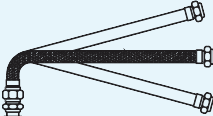
Do's	Don'ts	Do's	Don'ts
			
			
			
			
			
			

● Two (2) times hose O.D. is the minimum distance that must be free of bend

Selecting & Installing Hose Assemblies

Live Length Calculations

For the following formulas:

L	Live length of hose (inches/mm)
T	Travel (inches/mm)
S	Hose outside diameter (see product data pages herein)
R	Bend radius, measured to hose center-line

Verify that the installed radius is greater than the stated Minimum Bend Radius for the hose at the required working pressure. Verify that the centerline of the hose remains in the same plane during cycling to prevent twisting of assembly.

Constant Radius Traveling Loop (A-Loop)

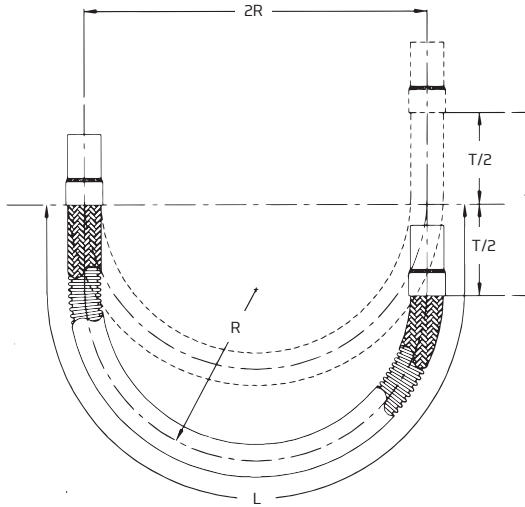

Formula: $L = 4R + 1/2T$

Variable Radius Traveling Loop (B-loop)

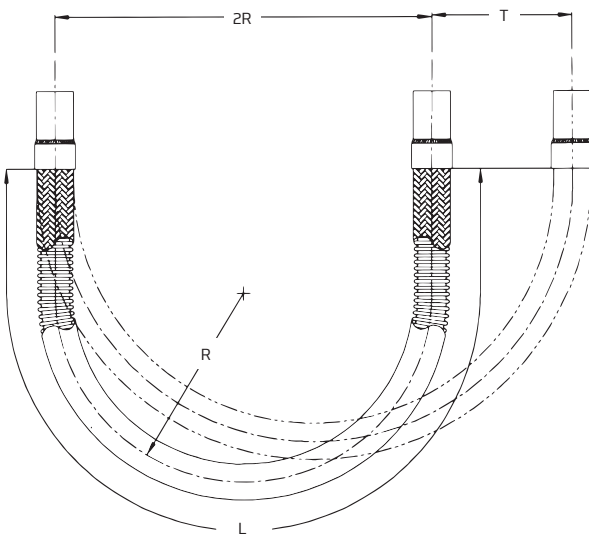

Formula: $L = 4R + 1.57T$

Lateral Offset

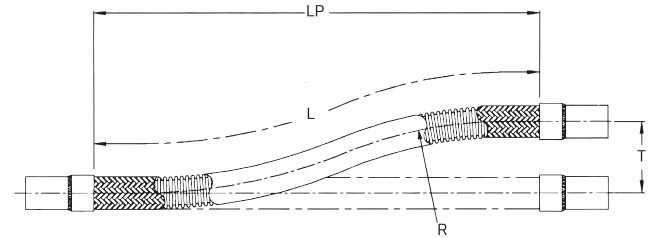

Formula: $L = \sqrt{20R \times T}$, $L_p = \sqrt{L^2 - T^2}$

Note 1: When the offset motion occurs on both sides of the hose centerline, use total travel in the formula

Note 2: The offset distance "T" for constant flexing should never exceed 25% of the centerline bend radius

Angular Deflection

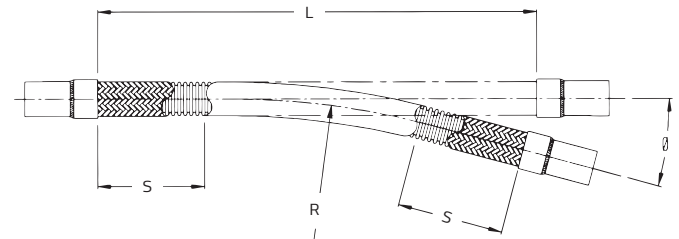

Formula: $L = 2S + (0/57.3)R$

Vertical Loop With Movement In Two Directions (combination loop)

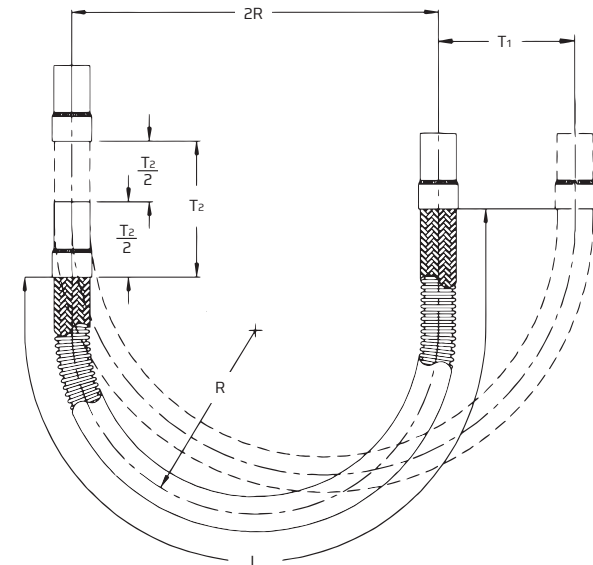

Formula: $L = 4R + 1.57T_1 + (T_2/2)$

Selecting & Installing Hose Assemblies

Vibration

The following graph is a representative guideline for estimation purposes only.

For any questions, or if your application is near the “Consult Factory” region, please contact your UCT Fluid Solutions local representative.

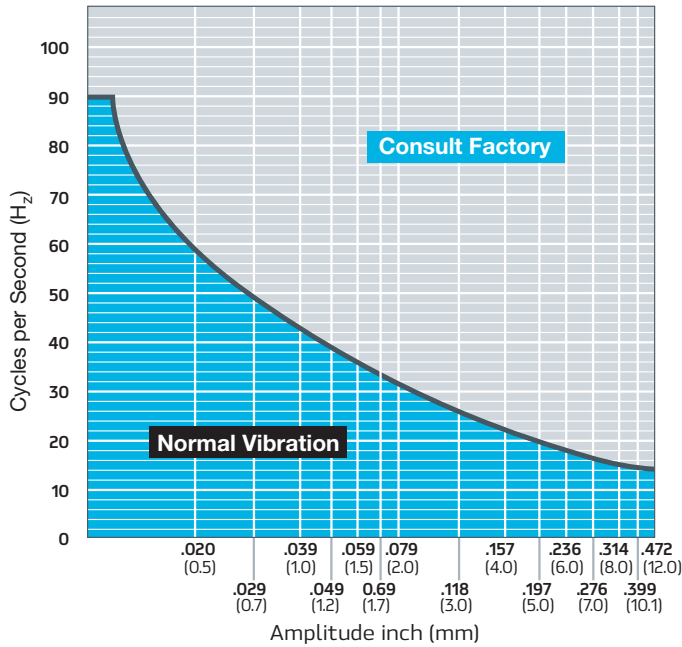

When installing a hose assembly in a vibration application, make sure to install it so the axis of the hose is perpendicular to the direction of the vibration.

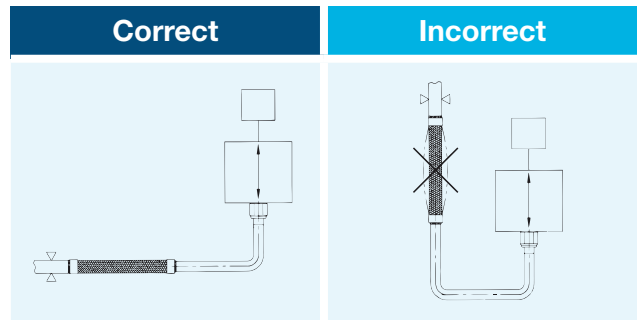

If there is vibration in more than one direction, either install a longer hose bent at 90° or install a “Dog Leg” assembly.

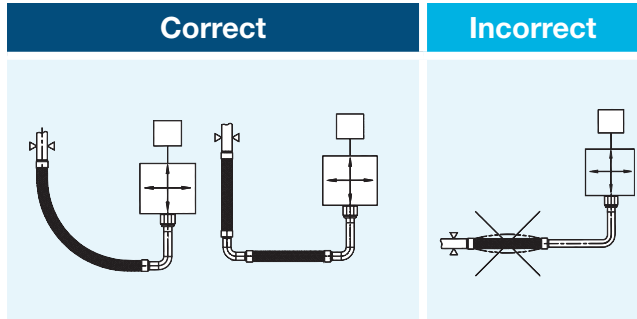



HAM-LET METAL HOSES

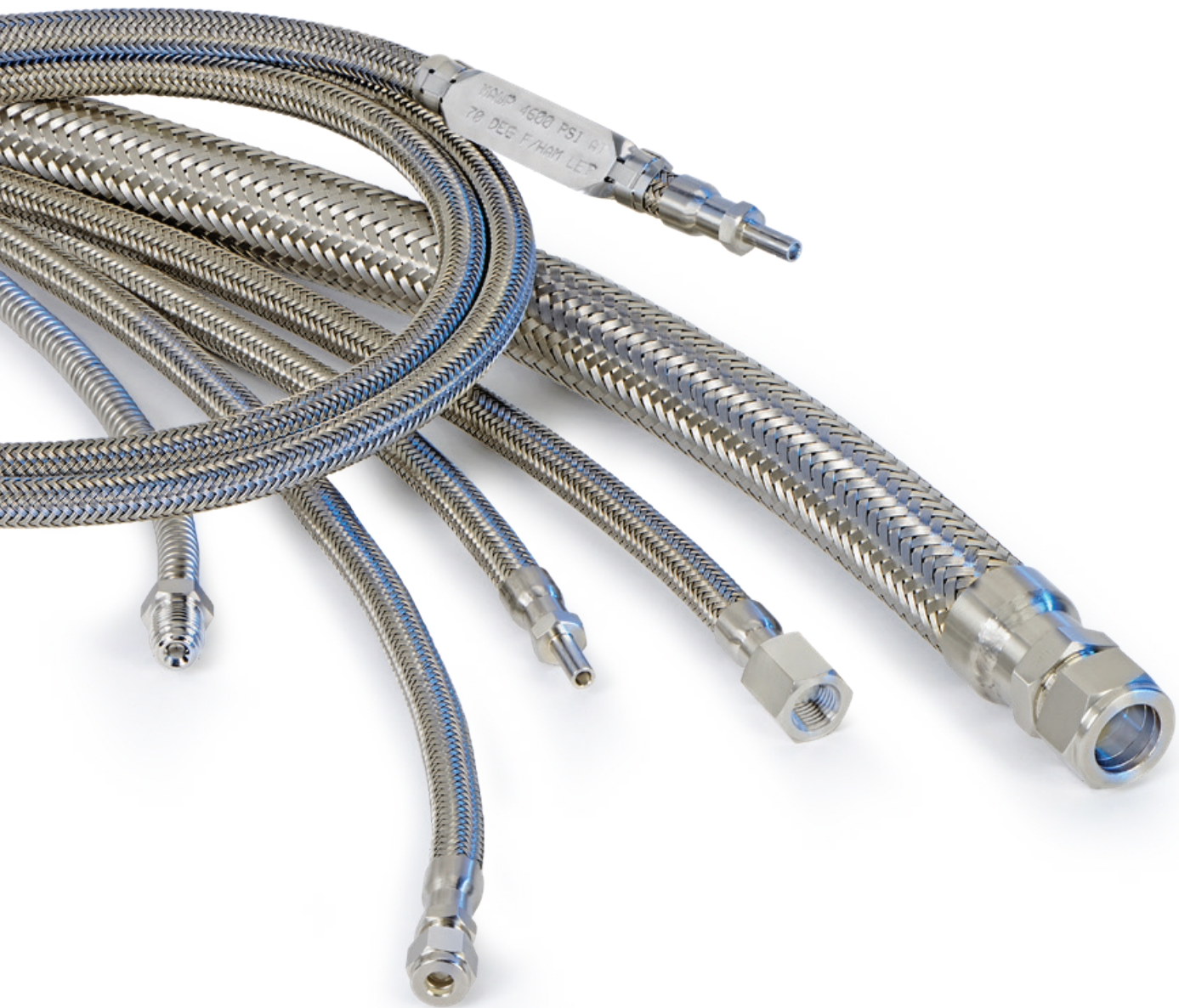

HAM-LET METAL HOSES

General

The Metal Hoses are top quality, stainless steel factory welded assemblies that are manufactured and tested to meet industry demands and regulations for Chemical, Process, Oil & Gas, Power Generation, Pumps & Vacuum, Instrumentation, Gases and Semiconductor Manufacturing.

The Metal Hose and components are manufactured from superior materials and components and comply with best industry standards for leak free durable performances.

Our flexible metal hoses are the best solution for a flexible connection of Gas & Liquid lines where vibrating, moving parts and installations involve high temperatures, chemicals and aggressive media, high pressures and full vacuum.

Features

- All stainless steel assembly
- LET-LOK[®], ONE-LOK, Face seal, UH Line end fittings
- ID sizes: 1/4" up to 2"
- Pressure rating: Vacuum to 6,000 psi (414 bar), 4 to 1 safety factor
- Working temperatures -425°F (-254°C) up to 1300°F (705°C)
- Hydroformed corrugated inner hose
- Machine braided (braid is woven directly on inner hose)
- Maximum Working Pressure marked on metal tag as standard.
- Manufactured in accordance to:
 - NAHAD – Corrugated Metal Hose Assembly specification guidelines
 - DIN ISO 10380 for designated items
 - Pipework – Corrugated metal hoses and hose assemblies

Metal Hoses Manufacturing Process

Corrugated Tube

A high-quality stainless steel thin walled tube is specifically manufactured. As a second stage, corrugations are formed into the tube hydraulically using a unique process called "Hydroforming" (rather the commonly used mechanical method). Hydroforming process evenly distributes stress on the tube wall. This unique method maintains wall thickness, reduces concentrated residual stress, and minimizes work hardening, resulting in enhanced flexibility and a prolonged cycle life.

Hydroformed

Evenly distributed stress

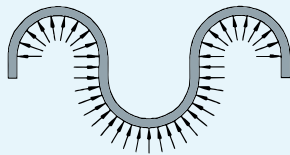

Mechanically Formed

Concentrated stresses

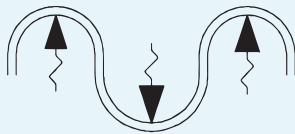

Hydroforming is a clean process, using water to form the hose, while most other processes require lubrication.

Hydroforming - UCT Fluid Solutions utilizes a proprietary method of hydroforming in which corrugations are formed by expanding a section of stainless steel tube with high pressure water from inside the tube, while simultaneously feeding the tube axially into the process. Hydroforming is a clean, gentle process that enhances flexibility and cycle life, maintains wall thickness, reduces concentrated residual stress, and minimizes work hardening of materials.

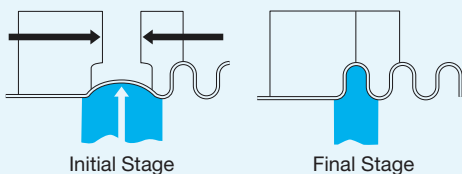

Braid

As a third (optional) stage, stainless steel wire is braided over the hose enabling the corrugated hose the ability to withstand higher pressures. Hoses may be single braided (one layer of braid) or

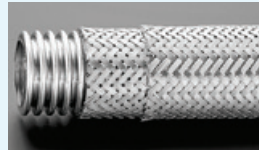

double braided (two layers of braid) to achieve even greater working pressures.

Braiding Superiority - Highest percentage of braid coverage, yielding better life cycle and protection against hose damages.

Machine Braided - The braid is woven directly onto the hose, ensuring that the braid fits tightly against the hose, preventing potential hose deformation or squirm. Machine braided hose also offers repeatable performance and longer life cycle.

Assembly

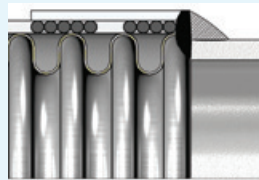

Combining top quality hoses with fittings together with a specialized welding, brazing, joining, fabrication procedures, and severe testing assures compatibility, integrity and serviceability of metal hose assemblies in even the most

extreme applications and demanding industries.

Standard assembly process consists of:

- Cutting the hose and braid through a hoses corrugation valley.
- Installing a braid collar over each end of the hose.
- Trimming of any excess braid.
- "Cap" welding the hose, braid, and braid collar together.
- Cleaning the cap weld surface.
- Placement and alignment of a fitting on the cap weld.
- "Attachment" welding the fitting to the cap weld.
- The assembled hose is tested, cleaned, marked and packed as required.

Metal Hose Selecting Considerations:

When selecting a Flexible Metal Hose, please consider the following characteristics:

1. Temperature

As the media or ambient temperature increases, the hose working pressure decreases. Review table below to see de-rating factor per temperature and hose material. Then multiply the hose maximum allowable working pressure by the most limiting temperature de-rating factor. Maximum allowable working pressures are marked on metal tag as standard.

Working Pressure de-Rating Factor:

Temp. in		304	304L	316	316L	321	C-276
Degrees F	Degrees C						
70	20	1.00	1.00	1.00	1.00	1.00	1.00
100	40	1.00	1.00	1.00	1.00	1.00	1.00
200	95	1.00	1.00	1.00	1.00	1.00	1.00
300	150	1.00	1.00	1.00	1.00	1.00	1.00
400	205	0.94	0.93	0.97	0.93	1.00	1.00
500	260	0.88	0.86	0.90	0.86	0.96	0.99
600	315	0.82	0.81	0.85	0.81	0.91	0.93
650	345	0.81	0.79	0.84	0.79	0.89	0.90
700	370	0.80	0.77	0.82	0.77	0.87	0.88
750	400	0.78	0.75	0.81	0.75	0.86	0.86
800	430	0.76	0.74	0.80	0.74	0.84	0.84
850	455	0.75	0.72	0.79	0.72	0.84	0.83
900	480	0.73	0.71	0.78	0.71	0.83	0.82
950	510	0.72	0.69	0.77	0.69	0.81	0.81
1000	540	0.69	0.67	0.77	0.67	0.81	0.80
1050	565	0.61	0.65	0.73	0.65	0.70	0.68
1100	595	0.49	0.62	0.62	0.61	0.55	0.55
1150	620	0.39	0.53	0.49	0.52	0.41	0.47
1200	650	0.30	0.38	0.37	0.38	0.32	0.36
1250	675	0.24	0.28	0.28	0.28	0.25	0.29
1300	705	-	0.21	0.21	0.21	-	-

2. Dynamic Pressure

Pulsating, surge or shock pressures, like those encountered by quick opening or closing valves, can inflict severe damage on a hose. Pulsating pressure or surges, de-rate the maximum allowable working pressure to 1/2 of its original value.

Shock pressures, de-rate the maximum allowable working pressure to 1/6 of its original value.

Example: 1/4" hose - T316L stainless steel hose and T304L stainless steel braid at 500°F with shock pressures:
 Catalog Maximum Working Pressure = 1800 psi
 Temperature De-rating Factor at 500°F = 0.86 psi
 Pressure De-rating Factor = 1/6 Maximum Application Working
 Allowable working pressure = 1800 PSI x 0.86 x 1/6 = 258 psi

3. Flexibility

Verify that the minimum bend radius of the hose is less than the bend radius required.

Larger installation radius reduces fatigue on the hose for a longer assembly life.

4. Chemical Compatibility

The material that you choose for the hose and braid must be compatible with the media that will flow through the hose, as well as the environment in which the hose is installed. When determining chemical compatibility, be sure that you know the temperature and composition of the chemicals in use. Although there are many resources to confirm chemical compatibility, two of the industry standards that you may find useful are the National Association of Corrosion Engineers (NACE) and the Compass Corrosion Guides.

Accessories

Optional accessories available include spring guards, protective covers, insulating covers and protective armor.

Cleaning & Packing

The hydroforming hose manufacturing process yields a very clean product.

Clean and Degrease to CGA G-4.1 "Oxygen Clean" is available. Ultrasonic Cleaning for Pharmaceutical applications is available. Each hose is packed in a plastic bag, end connections are capped.

Testing

All hose assemblies are tested, Helium leak testing up to 1×10^{-6} Std. CC/Sec. as standard. Helium leak testing up to 1×10^{-9} Std. CC/Sec is available.

*Helium leak test is available for hoses up to 100 inch (30m)

Selecting & Installing Metal Hose Assemblies

Media Flow Velocity

When gas liquid is conveyed in a corrugated metal hose exceeds certain limits, resonant vibration can occur. Resonance may cause a very rapid failure of the assembly. In applications where product velocities exceed the limits shown in the chart below, a revision of the assembly design might include:

1. An addition of an interlocked metal hose liner
2. An increase in the corrugated hose I.D.
3. A combination of the above

Velocity in Metal Hose

Installation Configuration	Maximum Product Velocity Feet/Second (Meter/Second)			
	Unbraided		Braided	
	Dry Gas	Liquid	Dry Gas	Liquid
Straight Run	100 (30)	50 (15)	150 (46)	75 (23)
45 Degree Bend	75 (23)	40 (12)	115 (35)	60 (18)
90 Degree Bend	50 (15)	25 (8)	75 (23)	40 (12)
180 Degree Bend	25 (8)	12 (4)	38 (12)	19 (6)

Pressure Drop

Pressure drop in a piping system is often a concern for the designer. Compared to rigid tubes, there is always a greater pressure drop in corrugated metal hoses. The following graphs are offered as aids in estimating pressure drop in corrugated hose conveying water and air. The values derived are approximate and apply only to straight-line installations. Bends and fittings can increase the pressure drop.

Pressure Drop Graph For Water

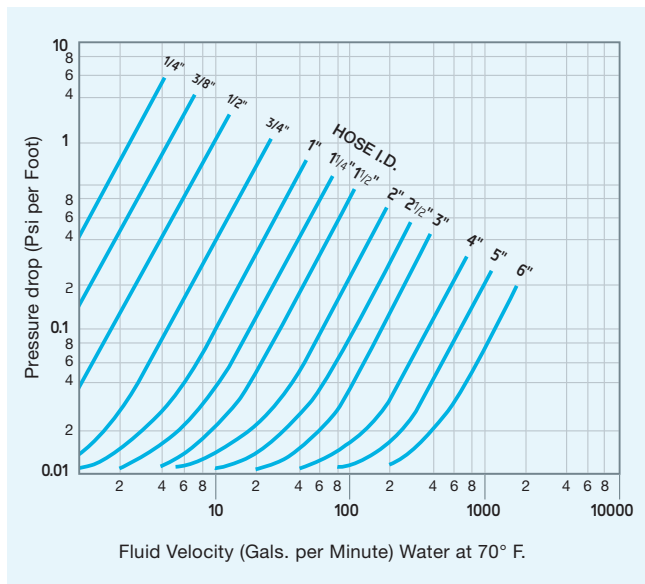

Pressure Drop Graph For Air

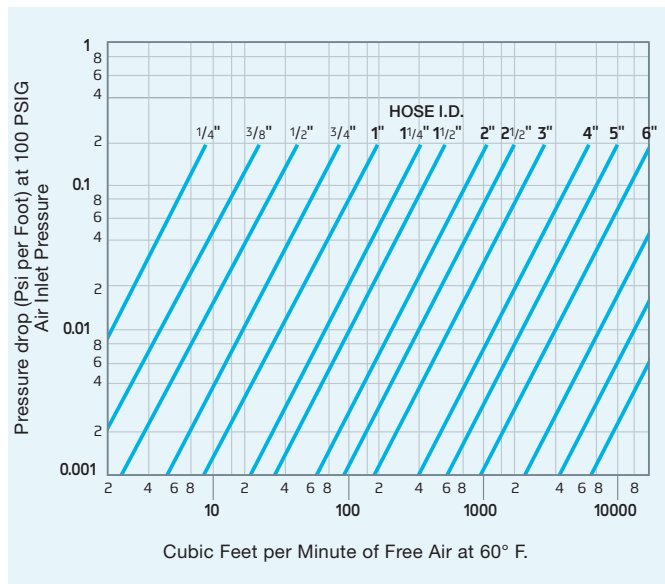

SHF Series - General Use

General

The SHF – General Use Hose series is our standard hose for industrial applications ,gas & liquid lines with high temperatures, corrosive media and harsh environments.

Features

- Braided, double braided or unbraided corrugated tube assembly
- Core tube is made of 316L stainless steel, 321 stainless steel core tube also available
- Braid is made of 304 stainless steel, 316 stainless steel braid is available
- Annular Hydroformed corrugation
- Tube ID from ¼” to 2”
- Max. working pressure 2700psi (186bar)
- Min. static bend radius for braided hose 1.0inch (25mm)
- Min. dynamic bend radius for braided hose 4.5inch (114mm)
- Full range of end connections

Inside Diameter		Number of Braids	Outside Diameter		Static Minimum Bend Radius		Dynamic Minimum Bend Radius		Maximum Working Pressure		Burst Pressure		Weight Per Foot	Weight Per Meter
inch	mm		inch	mm	inch	mm	inch	mm	psi	bar	psi	bar	lbs	kg
1/4	6.35	0	0.41	10.4	1.0	25	4.5	114	90	6	N/A	N/A	0.04	0.06
		1	0.47	11.9					1,800	124	7,233	499	0.11	0.16
		2	0.53	13.5					2,700	186	9,100	627	0.18	0.27
3/8	9.53	0	0.55	14.0	1.2	30	5.0	127	70	5	N/A	N/A	0.06	0.09
		1	0.61	15.5					1,558	107	6,230	430	0.16	0.24
		2	0.67	17.0					2,336	161	9,345	644	0.25	0.37
1/2	12.70	0	0.77	19.6	1.5	38	5.5	140	70	5	N/A	N/A	0.11	0.16
		1	0.83	21.1					1,186	82	4,743	327	0.22	0.33
		2	0.89	22.6					1,779	123	7,115	491	0.33	0.49
5/8	15.88	0	0.96	24.4	1.8	46	7.0	178	57	4	N/A	N/A	0.17	0.25
		1	1.02	25.9					1,205	83	4,820	332	0.33	0.49
		2	1.08	27.4					1,808	125	7,230	498	0.49	0.73
3/4	19.05	0	1.08	27.4	2.1	53	8.0	203	43	3	N/A	N/A	0.18	0.27
		1	1.14	29.0					898	62	3,591	248	0.35	0.52
		2	1.20	30.5					1,347	93	5,387	371	0.53	0.79
1	25.40	0	1.32	33.5	2.7	69	9.0	229	43	3	N/A	N/A	0.23	0.34
		1	1.39	35.3					718	50	2,872	198	0.47	0.70
		2	1.45	36.8					1,077	74	4,308	297	0.71	1.06
1 1/4	31.75	0	1.75	44.5	3.1	79	10.0	254	43	3	N/A	N/A	0.29	0.43
		1	1.83	46.5					645	44	2,581	178	0.61	0.91
		2	1.91	48.5					968	67	3,872	267	0.93	1.38
1 1/2	38.10	0	2.08	52.8	3.9	99	11.0	279	28	2	N/A	N/A	0.47	0.70
		1	2.16	54.9					531	37	2,125	147	0.85	1.26
		2	2.24	56.9					797	55	3,188	220	1.23	1.83
2	50.80	0	2.61	66.3	5.1	130	13.0	330	14	1	N/A	N/A	0.59	0.88
		1	2.69	68.3					449	31	1,797	124	1.11	1.65
		2	2.77	70.4					674	46	2,696	186	1.63	2.43



Materials of Construction

Part	Material
Tube	SST 316L / SST 321
Braid	SST 304 / SST 316
End Connections	SST 316L

SHE Series - Extra Flexible

General

The SHE – Extra Flexible Hose series provides improved flexibility for smaller minimal static and dynamic bend radii. The extra flexibility is provided by denser corrugations while maintaining the same pressure rate.

Features

- Braided, double braided or unbraided corrugated tube assembly
- Core is made of 316L stainless steel, 321 stainless steel core tube is available
- Braid is made of 304 stainless steel, 316 stainless steel braid is available
- Annular Hydroformed corrugation
- Tube ID from ¼” to 2”
- Max. working pressure 2700psi (186bar)
- Min. static bend radius for braided hose 0.9inch (23mm)
- Min. dynamic bend radius for braided hose 3.7inch (94mm)
- Full range of end connections

Inside Diameter		Number of Braids (#)	Outside Diameter		Static Minimum Bend Radius		Dynamic Minimum Bend Radius		Maximum Working Pressure		Burst Pressure		Weight Per Foot	Weight Per Meter
inch	mm		inch	mm	inch	mm	inch	mm	psi	bar	psi	bar	lbs	kg
1/4	6.35	0	0.42	10.7	0.9	23	3.7	94	90	6	N/A	N/A	0.07	0.10
		1	0.48	12.2					1,800	124	7,233	499	0.14	0.21
		2	0.54	13.7					2,700	186	9,100	627	0.20	0.30
3/8	9.53	0	0.55	14.0	1.0	25	4.0	102	70	5	N/A	N/A	0.07	0.10
		1	0.61	15.5					1,558	107	6,230	430	0.17	0.25
		2	0.67	17.0					2,336	161	9,345	644	0.27	0.40
1/2	12.70	0	0.77	19.6	1.2	30	4.4	112	70	5	N/A	N/A	0.18	0.27
		1	0.83	21.1					1,186	82	4,743	327	0.32	0.48
		2	0.89	22.6					1,779	123	7,115	491	0.47	0.70
3/4	19.05	0	1.08	27.4	1.7	43	6.4	163	43	3	N/A	N/A	0.23	0.34
		1	1.14	29.0					898	62	3,591	248	0.40	0.60
		2	1.20	30.5					1347	93	5,387	371	0.58	0.86
1	25.40	0	1.32	33.5	2.1	53	7.1	180	43	3	N/A	N/A	0.30	0.45
		1	1.39	35.3					718	50	2,872	198	0.53	0.79
		2	1.45	36.8					1,077	74	4,308	297	0.78	1.16
1 1/4	31.75	0	1.75	44.5	2.5	64	7.9	201	43	3	N/A	N/A	0.63	0.94
		1	1.83	46.5					645	44	2,581	178	1.00	1.49
		2	1.91	48.5					968	67	3,872	267	1.37	2.04
1 1/2	38.10	0	2.08	52.8	3.1	79	8.7	221	28	2	N/A	N/A	0.70	1.04
		1	2.16	54.9					531	37	2,125	147	1.16	1.73
		2	2.24	56.9					797	55	3,188	220	1.63	2.43
2	50.80	0	2.61	66.3	4	102	10.3	262	14	1	N/A	N/A	0.88	1.31
		1	2.69	68.3					449	31	1,797	124	1.44	2.14
		2	2.77	70.4					674	46	2,696	186	1.99	2.96



Materials of Construction

Part	Material
Tube	SST 316L / SST 321
Braid	SST 304 / SST 316
End Connections	SST 316L

SHJ Series - Flexible High Pressure

General

The SHJ - High Pressure Flexible Hose series is a hydroformed annular corrugated metal hose, made from heavy-wall stainless steel.

SHJ offers more flexibility and dependability at higher pressures.

Features

- Braided, double braided or unbraided corrugated tube assembly
- Core tube is made of 316L stainless steel, 321 stainless steel core tube is available from 1" up to 2"
- Braid is made of 304 stainless steel, 316 stainless steel braid is available
- Annular Hydroformed corrugation
- Tube ID 1/4" up to 2"
- Max. working pressure 4000psi (276 bar), 4 to 1 safety rate factor
- Min. static bend radius for braided hose 1.0 inch (25mm)
- Min. dynamic bend radius for braided hose 5.5inch (140mm)
- Full range of end connections

Inside Diameter		Number of Braids (#)	Outside Diameter		Static Minimum Bend Radius		Dynamic Minimum Bend Radius		Maximum Working Pressure		Burst Pressure		Weight per Foot	Weight per Meter
Inch	mm		Inch	mm	Inch	mm	Inch	mm	psi	bar	psi	bar	lbs	kg
1/4	6.35	0	0.42	10.7	1.0	25	5.5	140	450	31	N/A	N/A	0.08	0.12
		1	0.48	12.2					3,000	207	12,000	827	0.15	0.22
		2	0.54	13.7					4,000	276	16,000	1,103	0.22	0.33
3/8	9.52	0	0.65	16.64	1.5	38	8.5	216	400	28	N/A	N/A	0.12	0.05
		1	0.73	18.67					2,400	166	9,600	662	0.31	0.14
		2	0.81	20.70					3,300	228	14,000	965	0.48	0.22
1/2	12.7	0	0.77	19.6	2.5	64	10.0	254	400	28	N/A	N/A	0.24	0.36
		1	0.85	21.6					2,400	165	9,600	662	0.40	0.6
		2	0.93	23.6					3,200	221	12,800	883	0.57	0.85
3/4	19.05	0	1.13	28.7	4.0	102	8.0	203	220	15	N/A	N/A	0.41	0.61
		1	1.19	30.2					1,100	76	4,430	305	0.58	0.86
		2	1.25	31.8					1,650	114	6,696	462	0.76	1.13
1	31.7	0	1.43	36.3	5.0	127	9.0	229	190	13	N/A	N/A	0.52	0.77
		1	1.49	37.8					1,000	69	4,187	289	0.76	1.13
		2	1.55	39.4					1,400	97	5,837	402	0.99	1.47
1 1/4	31.75	0	1.74	44.2	6.5	165	12.0	305	200	14	N/A	N/A	0.76	1.13
		1	1.82	46.2					900	62	3,758	259	1.13	1.68
		2	1.90	48.3					1,350	93	5,494	379	1.50	2.23
1 1/2	38.10	0	2.10	53.3	7.5	191	13.0	330	90	6	N/A	N/A	1.13	1.68
		1	2.18	55.4					750	52	3,070	212	1.54	2.29
		2	2.26	57.4					1,200	83	4,842	334	1.96	2.92
2	50.80	0	2.55	64.8	9.0	229	15.0	381	105	7	N/A	N/A	1.10	1.64
		1	2.68	68.1					800	55	3,304	228	2.29	3.41
		2	2.80	71.1					1,150	79	4,738	327	3.47	5.16



Materials of Construction

Part	Material
Tube	SST 316L / SST 321
Braid	SST 304 / SST 316
End Connections	SST 316L

SST 321 Tube is available for 1"-2"

Only SST 316L Tube is available for 1/4"-3/4"

SHU Series - Ultra High Pressure

General

The SHU – this Ultra High Pressure Hose series is a hydroformed annular, heavy-wall corrugated metal hose, specifically designed for ULTRA-high-pressure applications.

The SHU hoses offer superior flexibility and are made off heavy-wall 321 stainless steel.

Features

- Braided, double braided or unbraided corrugated tube assembly
- Core tube is made of 321 stainless steel, 316L stainless steel core tube is available
- Braid is made of 321 stainless steel
- Annular Hydroformed corrugation
- Tube ID 1/4" up to 2"
- Max. working pressure 6000psi (414bar), 4 to 1 safety rate factor
- Min. static bend radius for braided hose 1.5 inch (38mm)
- Min. dynamic bend radius for braided hose 4.5inch (114mm)
- Full range of end connections

Inside Diameter		Number of Braids (#)	Outside Diameter		Static Minimum Bend Radius		Dynamic Minimum Bend Radius		Maximum Working Pressure		Burst Pressure		Weight Per Foot	Weight Per Meter
inch	mm		inch	mm	inch	mm	inch	mm	psi	bar	psi	bar	lbs	kg
1/4	6.35	0	0.43	10.9	0.5	13	4.5	114	500	34	N/A	N/A	0.15	0.22
		1	0.56	14.1	1.5	38			5,000	345	20,000	1,379	0.32	0.48
		2	0.68	17.3	1.5	38			6,000	414	24,000	1,655	0.49	0.73
3/8	9.53	0	0.67	17.03	1.5	38.13	7.0	178	400	28	1,600	110	0.18	0.27
		1	0.80	20.21	2.5	63.55			3,500	241	14,000	965	0.46	0.68
		2	0.92	23.39	2.5	63.55			5,000	345	20,000	1,379	0.77	1.14
1/2	12.70	0	0.78	19.9	2.0	51	8.0	203	200	14	N/A	N/A	0.43	0.64
		1	0.88	22.5	3.0	76			2,700	186	10,800	744	0.64	0.95
		2	0.98	25.0	3.0	76			4,500	310	18,000	1,240	0.85	1.26
3/4	19.05	0	1.15	29.2	2.5	64	4.5	114	250	17	N/A	N/A	0.63	0.94
		1	1.28	32.5	4.0	102	10.0	254	2,650	183	10,669	736	1.09	1.62
		2	1.40	35.6	4.0	102	10.0	254	3,600	248	14,521	1,001	1.58	2.35
1	25.40	0	1.45	36.8	3.25	83	7.0	178	180	12	N/A	N/A	0.84	1.25
		1	1.57	39.9	5.0	127	11.0	279	2,500	172	10,000	689	1.53	2.28
		2	1.70	43.2	5.0	127	11.0	279	3,000	207	12,083	833	2.25	3.35
1 1/4	31.75	0	1.75	44.5	5.0	127	9.5	241	190	13	N/A	N/A	1.32	1.96
		1	1.88	47.8	6.5	165	12.5	318	1,775	122	7,119	491	2.09	3.11
		2	2.00	50.8	6.5	165	12.5	318	2,600	179	10,400	717	2.88	4.29
		3	2.13	54.1	7.0	178	14.0	356	3,000	207	12,082	833	3.71	5.52
1 1/2	38.10	0	2.11	53.6	6.0	152	11.5	292	110	8	N/A	N/A	1.75	2.60
		1	2.23	56.6	7.5	191	13.0	330	1,450	100	5,800	400	2.64	3.93
		2	2.36	59.9	7.5	191	13.0	330	2,200	152	8,892	613	3.57	5.31
2	50.80	0	2.57	65.3	7.5	191	12.0	305	100	7	N/A	N/A	2.04	3.04
		1	2.70	68.6	9.0	229	14.0	356	1,100	76	4,415	304	3.23	4.81
		2	2.82	71.6	9.0	229	14.0	356	1,675	115	6,710	463	4.45	6.62



Materials of Construction

Part	Material
Tube	SST 321 / SST 316L
Braid	SST 321
End Connections	SST 316L

SST 321 Tube is available for 1"-2"

Only SST 316L Tube is available for 1/4"-1/2"

SHV Series - Formable

General

The SHV – Formable Hose series are manually formable tubes that keep their formation. These hoses are designed to bend and stay in one position, providing a stress-free connection between tubing systems.

SHV hoses can be compressed or stretched to fit into an exact space in the system

Features

- Braided or unbraided corrugated tube assembly
- Core tube is made of 321 stainless steel, 316L stainless steel core tube is available
- Braid is made of 304 stainless steel
- Annular Hydroformed corrugation
- Tube ID 1/4", 3/8", 1/2"
- Max. working pressure 900psi (62bar)
- Min. static bend radius for braided hose 1.0inch (25mm)
- Full range of end connections

Inside Diameter		Number of Braids	Outside Diameter		Static Minimum Bend Radius		Dynamic Minimum Bend Radius		Maximum Working Pressure		Burst Pressure		Weight Per Foot	Weight Per Meter
inch	mm		inch	mm	inch	mm	inch	mm	psi	bar	psi	bar	lbs	kg
1/4	6.35	0	0.41	10.4	1.0	25	N/A	N/A	90	6	N/A	N/A	0.04	0.06
		1	0.47	11.9					900	62	3,600	248	0.11	0.16
3/8	9.53	0	0.65	16.5	1.2	30	N/A	N/A	70	5	N/A	N/A	0.10	0.15
		1	0.71	18.0					800	55	3,200	221	0.17	0.25
1/2	12.70	0	0.77	19.6	1.5	38	N/A	N/A	70	5	N/A	N/A	0.11	0.16
		1	0.83	21.1					665	46	2,660	183	0.19	0.28



Materials of Construction

Part	Material
Tube	SST 321 / SST 316L
Braid	SST 304
End Connections	SST 316L

AHF Series - Standard

General

This chemical resistant, annular corrugated metal hose is manufactured with a special C-276 alloy.

Features

- Braided, double braided or unbraided corrugated tube assembly
- Core tube is made of C-276 alloy
- Braid is made of 316 stainless steel, C-276 alloy braid is available
- Annular Hydroformed corrugation
- Tube ID from 1/2." to 1"
- Max. working pressure 1779psi (122.7bar)
- Min. static bend radius for braided hose 1.5 inch (38.1mm)
- Min. dynamic bend radius for braided 5.5 inch (139.7mm)

Inside Diameter		Number of Braids (#)	Outside Diameter		Static Minimum Bend Radius		Dynamic Minimum Bend Radius		Maximum Working Pressure		Burst Pressure		Weight Per Foot	Weight Per Meter
inch	mm		inch	mm	inch	mm	inch	mm	psi	bar	psi	bar	LBS	KG
1/2	12.7	0	0.77	19.56	1.5	38.1	5.5	139.7	70	4.8	N/A	N/A	0.11	0.24
		1	0.83	21.08					1186	81.8	4743	327.1	0.22	0.49
		2	0.89	22.61					1779	122.7	7115	490.7	0.33	0.73
3/4	19.05	0	1.16	29.46	2.1	53.34	8	203.2	43	3.0	N/A	N/A	0.19	0.42
		1	1.22	30.99					898	61.9	3591	247.7	0.37	0.82
		2	1.28	32.51					1347	92.9	5387	371.5	0.55	1.22
1	25.4	0	1.47	37.34	2.7	68.58	9	228.6	43	3.0	N/A	N/A	0.26	0.58
		1	1.53	38.86					718	49.5	2872	198.1	0.5	1.11
		2	1.59	40.39					1077	74.3	4308	297.1	0.74	1.64

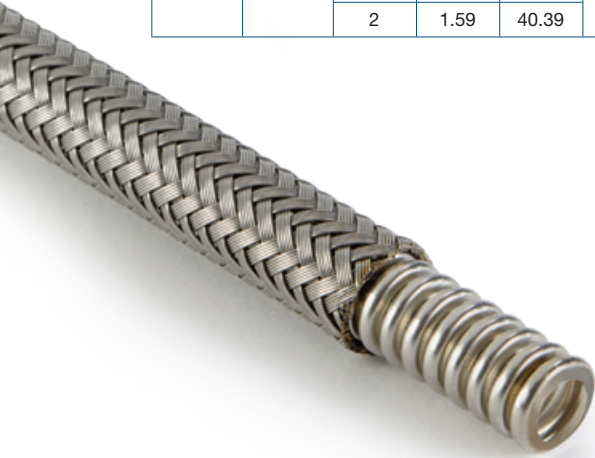

Materials of Construction

Part	Material
Tube	C-276
Braid	C-276 / SST 316
End Connections	SST 316L / C-276

SHP Series - Industrial Gas Applications Compatible

General

The SHP – Industrial Gas Application hose series is made of heavy wall and close pitch, annular corrugation obtained by hydroforming.

Dedicated to transfer chemicals, gases, steam under pressure and in high vacuum conditions.

Features

- Single or double braided corrugated tube assembly
- Core tube is made of 316L stainless steel
- Annular Hydroformed corrugation
- Tube ID 1/4" up to 2"
- Max. dynamic working pressure 3698psi (255bar)
- Min. static bend radius for braided hose 1.0 inch (25mm)
- Min. dynamic bend radius for braided hose 4.3 inch (110mm)
- Full range of end connections.
- Manufactured according EN ISO 10380

Inside Diameter		Number of Braids (#)	Outside Diameter		Static Minimum Bend Radius		Dynamic Minimum Bend Radius		Maximum Working Pressure (static cond)		Maximum Working Pressure (dynamic cond)		Burst Pressure	
inch	mm		inch	mm	inch	mm	inch	mm	psi	bar	psi	bar	psi	bar
1/4	6	1	0.45	11.4	1.0	25	4.33	110	3,263	225	2,610	180	10,440	720
		2	0.51	13					4,249	293	3,698	255	14,790	1,020
3/8	10	1	0.70	17.8	1.5	38	5.91	150	2,407	166	2,103	145	8,410	580
		2	0.76	19.4					3,234	223	2,828	195	11,310	780
1/2	12	1	0.80	20.2	1.8	45	6.50	165	2,538	175	2,030	140	8,120	560
		2	1.21	21.8					3,089	213	2,683	185	10,730	740
3/4	20	1	1.15	29.1	2.8	70	8.86	225	1,436	99	1,233	85	4,930	340
		2	1.21	30.7					2,132	147	1,813	125	7,250	500
1	25	1	1.50	38	3.3	85	8.46	215	1,320	91	1,131	78	4,524	312
		2	1.57	40			10.24	260	2,059	142	1,798	124	7,192	496
1 1/4	32	1	1.83	46.5	4.1	105	11.81	300	1,131	78	943	65	3,770	260
		2	1.93	49					1,943	134	1,668	115	6,670	460
1 1/2	40	1	2.16	54.9	5.1	130	11.02	280	986	68	885	61	3,538	244
		2	2.26	57.4			13.39	340	1,508	104	1,305	90	5,220	360
2	50	1	2.65	67.3	6.3	160	15.35	390	899	62	798	55	3,190	220
		2	2.75	69.8					1,334	92	1,131	78	4,524	312



Materials of Construction

Part	Material
Tube	SST 316L / SST 321
Braid	SST 304
End Connections	SST 316L

Cylinder Connections

End Connectors	Gas Types
FA CGA 320	Carbon Dioxide, Methyl Fluoride
FA CGA 350	Arsine, Ethane, Methane, Natural Gas
FA CGA 540	Oxygen
FA CGA 580	Argon, Helium, Krypton, Neon, Nitrogen, Xenon
FA CGA 590	Sulfur Hexafluoride

OPTIONAL

Metal Hoses - Ordering Information

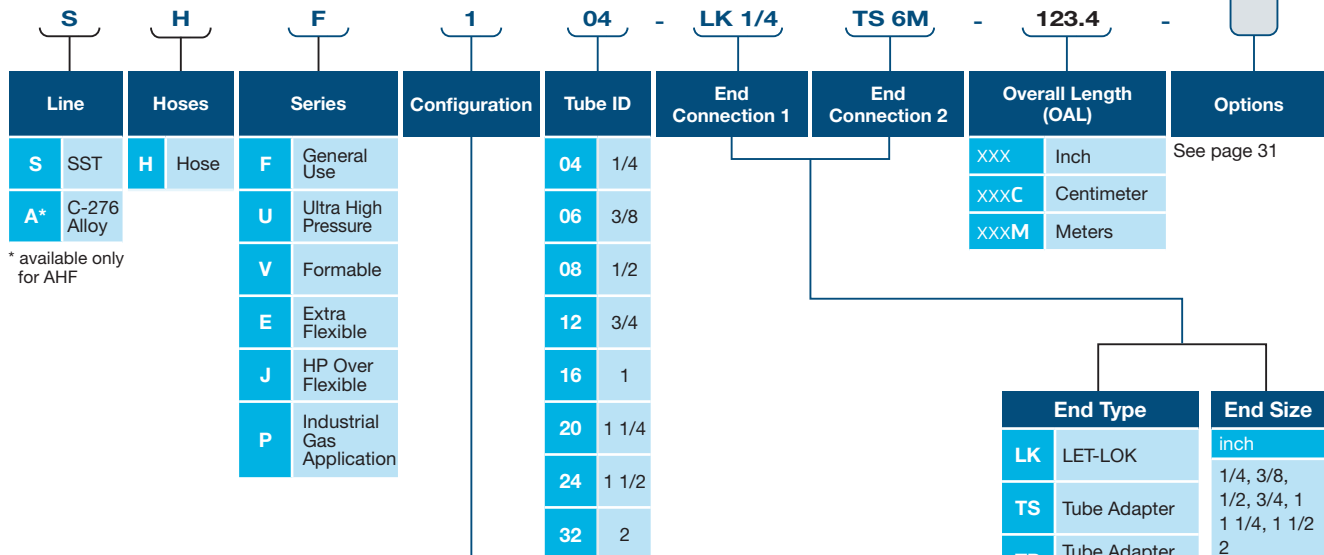

Line	Hoses	Series	Configuration	Tube ID	End Connection 1	End Connection 2	Overall Length (OAL)	Options
S	SST	F	1	04	LK 1/4	TS 6M	123.4	See page 31
A*	C-276 Alloy	U		06			XXX	
		V		08			XXXC	
		E		12			XXXM	
		J		16				
		P		20				

* available only for AHF

Tube ID	End Size
04	1/4
06	3/8
08	1/2
12	3/4
16	1
20	1 1/4
24	1 1/2
32	2

Overall Length (OAL)	Unit
XXX	Inch
XXXC	Centimeter
XXXM	Meters

See page 31

End Type	End Size
LK	LET-LOK
TS	Tube Adapter
TP	Tube Adapter Preswaged
GF	Face Seal Female Swivel
GM	Face Seal Male Swivel
FP	Female Pipe NPT
MP	Male Pipe NPT
FG	Female BSP-P
MG	Male BSP-P
LW	Long Butt Weld
FR	Female BSP-T
MR	Male BSP-T
BW	Butt Weld Adapter
HL	ONE-LOK®
UH	UH-Line (Vacuum only)
FH	Female Flare 37°
MF	Male Flare 37°
LW	Long Butt Weld
SW	Tube Socket Weld Elbow
HF	High Flow Face Seal

Configuration

Series	Configuration	Tube Material	Braid Material	# of Braids
F	0	316L	-	0
	1	316L	304	1
	2	316L	304	2
	3	321	-	0
	4	321	304	1
	5	321	304	2
	6	316L	316	1
	7	316L	316	2
	8	321	316	1
9	321	316	2	
U	3	316L	-	0
	4	316L	321	1
	5	316L	321	2
V	0	321	-	0
	1	321	304	1
	2	316L	-	0
	3	316L	304	1
E	0	316L	-	0
	1	316L	304	1
	2	316L	304	2
	3	321	-	0
	4	321	304	1
	5	321	304	2
	6	316L	316	1
	7	316L	316	2
	8	321	316	1
9	321	316	2	

Series	Configuration	Tube Material	Braid Material	# of Braids
J	1	316L	304	1
	2	316L	304	2
	6	316L	316	1
	7	316L	316	2
P	0	316L	304	1
	1	316L	304	2
AHF	1	C-276	316	1
	2	C-276	316	2
	3	C-276	-	0
	4	C-276	C-276	1
	5	C-276	C-276	2

Warning!

The system designer and user have the sole responsibility for selecting products suitable for their special application requirements, ensuring their safe and trouble-free installation, operation, and maintenance. Application details, material compatibility and product ratings should all be considered for each selected product. Improper selection, installation or use of products can cause property damage or personal injury.

Metal Hoses - Options

Test		Cleaning	Internal Lamina	Re-order per pictures		Tagging		
H	Helium Leak Test 1×10^{-9} Std. CC/Sec	O Oxygen Cleaning	L Liner Not available for 1/4" size. Not available for 3/8" & 1/2" sizes in SHJ/SHU series.	A	Armor	P	Plastic Tag	None On One End
				R	Protective Cover	M	Metal Tag ⁽¹⁾	B Both Ends ⁽²⁾
				J	Fire insulation Jacket			Z Crimp Ring/ Etching**
				K	Thermal Insulation Cover			

**Can not be performed on braidless hose series

(1) Metal tag is default for all metal hoses (There is no need to specify in the order information)
MAWP, hose description, and batch/serial number are marked

(2) Metal tags cannot be assembled on both ends
Instead, etched collars could be used

Cover Options



Armor Protection

A mechanical armor can be installed with the hose assembly. This type of armor consists of a hard metallic shell protecting the flexible regions of the hose against damage from outside, i.e. kicks, falling objects, etc.



Protective Cover

For lighter protection of the corrugated hose braid, and to protect against penetration of particles a shrink wrap can be installed with the hose.



Fire Insulation Jacket

High temperature insulation of the hose exterior is available by adding an insulated protective jacket. The jacket consists of braided fiberglass insulation, covered and saturated with Silicone rubber that is then installed over the corrugated hose and sealed. The Fire jacket can also be used to prevent ambient heat from being conveyed to the media or to reduce media heat loss.

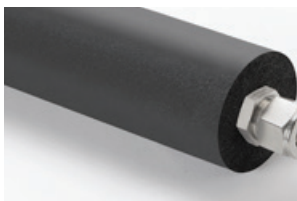

Thermal Insulation Cover

Thermal insulation of the hose exterior by adding a thermal insulation cover. Reduces heat loss of media by decreasing conduction and convection heat exchanges with the environment.



Tagging

Customer or system information can be marked on hose assemblies using cardboard, plastic, and metal tags or permanently engraved onto braid collars. Tags and markings can be applied on single or both ends of assemblies.



HAM-LET PTFE HOSES

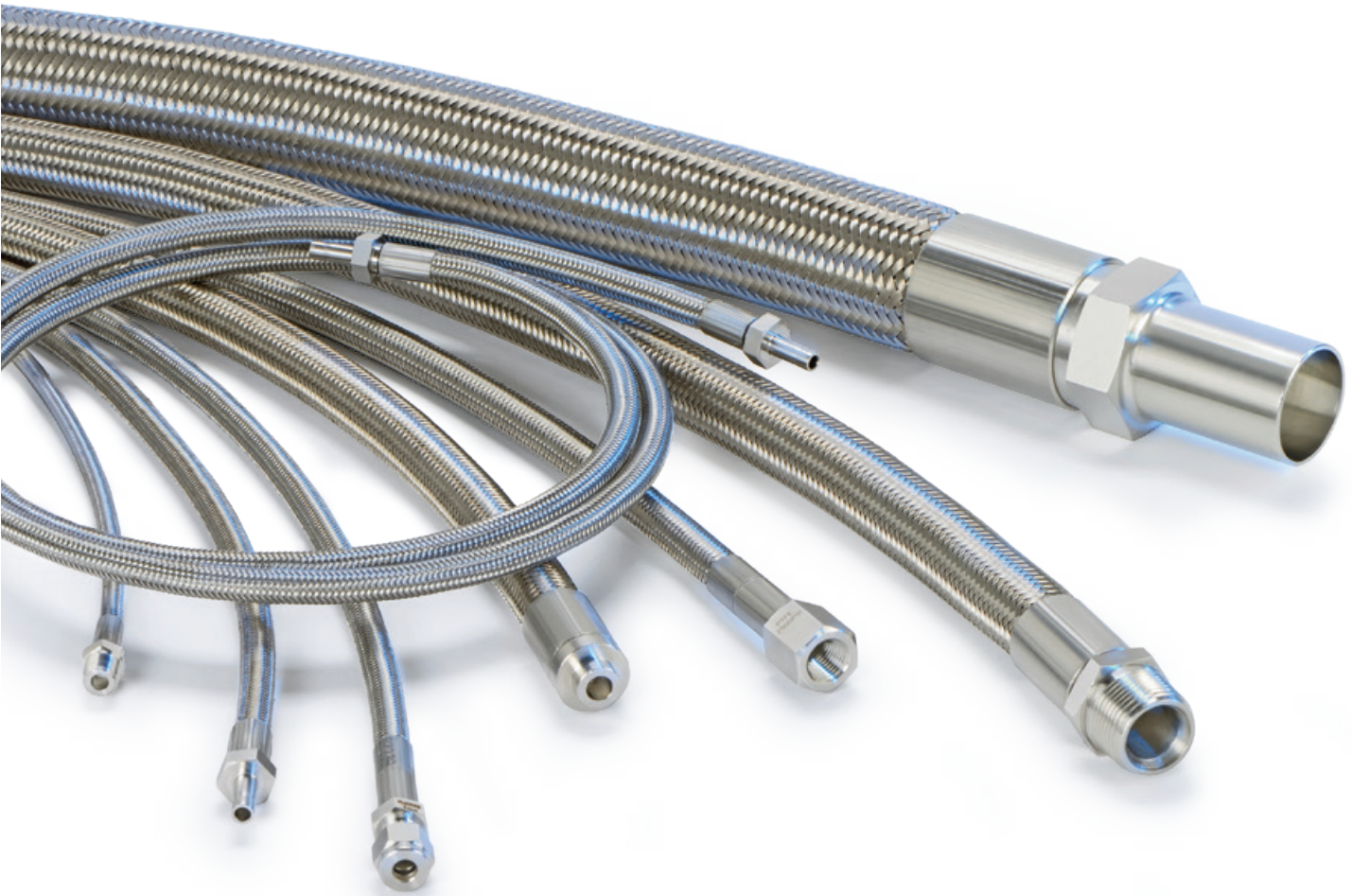

HAM-LET PTFE Hoses

General

PTFE stainless steel braided hose is an ideal solution for permanent or temporary connections for liquids. It makes fabrication easier, and facilitates quick connect/disconnect and cleaning. Variable length, high flexibility, high pressure and broad chemical compatibility are among the features that make this hose the preferred solution for many applications.

PTFE hoses are available in smooth, convoluted or conductive carbon lined core with stainless-steel braid or Silicone covered stainless-steel braided.

Testing & Packing

All hose assemblies are 100% tested.

All hoses are Hydrostatically tested at 1.5xMAWP.

All hoses are packed individually in a plastic bag, end connections are capped.

Each package contains the standard certificates COC, COT (pressure test).

Features

- PTFE core with all stainless steel braid and connections
- Non-contaminating, Non-absorbent, will not impart taste or odor
- Non-aging & non-stick surface
- Easy to clean, drain easily
- True I.D., Low friction
- LET-LOK, ONE-LOK, Male & Female NPT
- Max. pressure 3250 psi (224 bar), safety factor 1 to 4
- Working temperature: -100° ~ +500° F (-73° ~ + 260°C)
- Packed and Validated for high purity service with corresponding fittings:
 1. Compatible DIN EN 16643 standard
 2. Approved Food and Drug Administration (FDA) 21CFR177.1550

Working Pressure De-rating Factor

Temp °C	De-rating
150	1
190	0.85
210	0.75
260	0.5

Chemical Compatibility:

PTFE has one of the highest levels of chemical compatibility. Following is the list of materials that require some level of consideration:

The following materials are not recommended for use with PTFE hosing:

- Elemental Sodium
- Elemental Potassium
- Elemental Lithium

The materials listed below are only questionable if conveyed in conjunction with high temperature and pressure and/or a combination thereof:

- Fluorine (F2)
- Iodine Pentafluoride
- 80% and over Sodium Hydroxide
- Aluminum Chloride (at elevated temps)
- Ammonia (NH3)
- Temperature
- 70% Nitric Acid

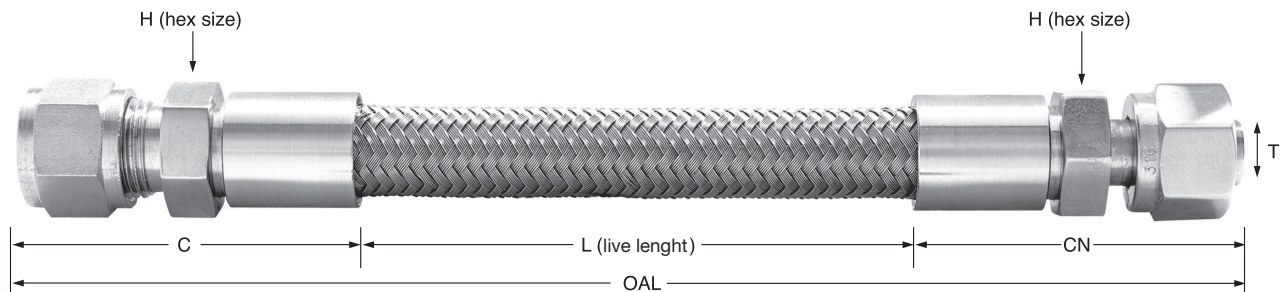

THT Series - Smooth PTFE Core SS Braided Hose

General

General use smooth PTFE core hoses.

Features

- Tube I.D. 1/8" up to 1"
- Pressure rating: Vacuum to 3,000 psi (207 bar)
- Min Bend radius 1.5 inch (38.1mm)
- Conductive inner lining available

Inside Diameter		Number of Braids	Maximum Working Pressure		Minimum Bend Radius		Outside Diameter		Burst Pressure		Weight Per Foot	Weight Per Meter
(inch)	(mm)		(psi)	(bar)	(inch)	(mm)	(inch)	(mm)	(psi)	(bar)		
1/8	3.18	1	3,000	207	1.5	38	0.25	6.35	12,000	827	0.05	0.07
1/4	6.35	1	2,600	180	3.0	76	0.38	9.65	12,000	827	0.1	0.15
3/8	9.53	1	2,300	160	5.0	127	0.50	12.70	10,000	688	0.12	0.18
1/2	12.70	1	1,500	103	6.5	165	0.65	16.51	6,000	414	0.16	0.24
3/4	19.05	1	1,100	75	9.0	229	0.89	22.61	4,000	276	0.22	0.33
1	25.40	1	900	62	12.0	305	1.14	28.96	4,000	276	0.51	0.76

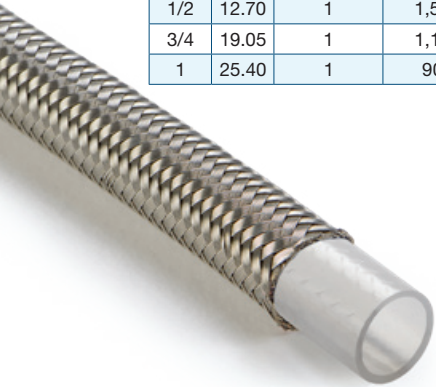

Materials of Construction

Part	Material
Tube	PTFE
Braid	SST 304
End Connections	SST 316L

THS Series - Silicone Covered Smooth PTFE Core SS Braided Hose

General

Special design for pharmaceutical, food & beverages and biotech applications. Silicone cover protects the braid from particles or other external contamination and distend high temperatures.

Features

- Tube I.D. 1/8" up to 1"
- Pressure rating: Vacuum to 3250psi (224bar)
- Min Bend radius 1.5 inch (38.1mm)

Inside Diameter		Number of Braids	Maximum Working Pressure		Minimum Bend Radius		Outside Diameter		Burst Pressure		Weight Per Foot	Weight Per Meter
(inch)	(mm)		(psi)	(bar)	(inch)	(mm)	(inch)	(mm)	(psi)	(bar)		
1/8	3.18	1	3,000	207	1.5	38	0.43	10.9	12,000	827	0.11	0.16
1/4	6.35	1	3,000	207	3.0	76	0.50	12.7	12,000	827	0.13	0.19
3/8	9.53	1	2,300	160	5.0	127	0.65	16.5	9,000	621	0.15	0.22
1/2	12.70	1	1,500	103	6.5	165	0.81	20.6	6,000	414	0.18	0.27
3/4	19.05	1	1,100	76	9.0	229	1.02	25.9	4,400	303	0.34	0.51
1	25.40	1	1,000	69	12.0	305	1.36	34.5	4,000	276	0.57	0.85



Hose Cover Color Code:

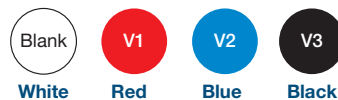

Note: THP can be offered as THS with red cover.
The THP series is no longer available but can be found in the THS series as V1.

Materials of Construction

Part	Material
Tube	PTFE
Braid	SST 304
External cover	Silicone
End Connections	SST 316L

THC Series - Convoluted PTFE Core SS Braided Hose

General

Convoluted PTFE core for extra flexibility with larger IDs. Completely drainable hose. Durable for high pressures and high temperatures with lower profile.

Features

- Tube I.D. 1/4" up to 2"
- Pressure rating: up to 1500psi (103bar)
- Min Bend radius 2.5 inch (63.5mm)
- Conductive inner lining available

Inside Diameter		Number of Braids	Maximum Working Pressure		Minimum Bend Radius		Outside Diameter		Burst Pressure		Weight Per Foot	Weight Per Meter
inch	mm		psi	bar	inch	mm	inch	mm	psi	bar		
1/4	6.35	1	2,500	172	0.71	18	0.48	12.3	7,500	517	0.11	0.16
3/8	9.53	1	2,000	136	0.79	20	0.60	14.75	6,000	414	0.14	0.21
1/2	12.70	1	1,500	103	0.98	25	0.74	18.80	6,000	414	0.19	0.28
3/4	19.05	1	1,000	69	2.52	64	0.97	24.64	4,395	303	0.27	0.40
1	25.40	1	670	46	3.50	89	1.29	32.77	3,000	207	0.39	0.58
1 1/2	38.10	1	330	23	5.98	152	1.90	48.26	2,805	193	0.75	1.12
2	50.80	1	330	23	7.87	200	2.42	61.47	2,100	145	0.89	1.32

*Pressure rating: 3 to 1 safety factory

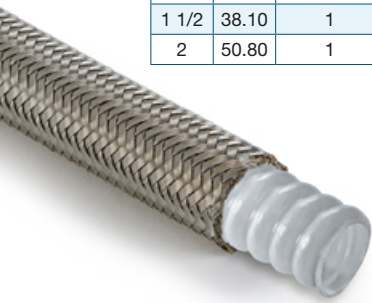

Materials of Construction

Part	Material
Tube	PTFE
Braid	SST 304
End Connections	SST 316L

General

Nonmetal smooth PTFE core hoses with fiberglass braid.

Features

- Tube I.D. 1/4" up to 3/4"
- Pressure rating: up to 800psi (55bar)
- Min Bend radius 2.75 inch (70mm)

THB Series - Smooth PTFE Core Fiberglass Braided Hose

Inside Diameter		Number of Braids	Maximum Working Pressure		Minimum Bend Radius		Outside Diameter		Burst Pressure		Weight Per Foot	Weight Per Meter
inch	mm		psi	bar	inch	mm	inch	mm	psi	bar		
1/4	6.35	1	800	55	2.75	70	0.41	10.50	3,200	220	0.06	0.09
3/8	9.53	1	800	55	3.25	83	0.56	14.22	3,200	220	0.12	0.18
1/2	12.7	1	800	55	5.25	133	0.73	18.03	3,200	220	0.13	0.19
3/4	19.05	1	400	27	6.50	165	0.95	24.19	1,600	110	0.20	0.30



Materials of Construction

Part	Material
Tube	PTFE
Braid	Fiberglass single braid
End Connections	SST 316L

* Only for liquid applications

THR Series - Smooth PTFE Core Fiberglass middle layer SS Braided Hose

General

Smooth PTFE core hose with additional fiberglass middle layer and external stainless steel braid for increased flexibility and insulation.

Features

- Tube I.D. 1/4" up to 1"
- Pressure rating Vacuum to 3,500 psi (241 bar)
- Min Bend radius 1.25 inch (32 mm)
- Conductive inner lining available

Inside Diameter		Number of Braids	Maximum Working Pressure		Minimum Bend Radius		Outside Diameter		Burst Pressure		Weight Per Foot	Weight Per Meter
inch	mm		psi	bar	inch	mm	inch	mm	psi	bar		
1/4	6.35	2	3,500	241	1.0	26	0.44	11.18	14,000	965	0.13	0.19
3/8	9.53	2	3,000	207	1.6	40	0.57	14.53	12,000	827	0.18	0.27
1/2	12.70	2	1,800	124	2.5	64	0.75	19.15	7,200	496	0.24	0.36
3/4	19.05	2	1,400	97	4.3	108	1.00	25.40	5,600	386	0.36	0.54



Materials of Construction

Part	Material
Tube	PTFE
Inner Braid	Fiberglass
Outer Braid	SST 304
End Connections	SST 316L

THQ Series - Multiple Cover Hose, Silicone Covered, SS Braided, Fiberglass supported, Smooth PTFE Core

General

Smooth PTFE core hose with additional fiberglass middle layer and external stainless steel braid for increased flexibility and insulation. Silicone cover protects the braid from particles or other external contamination and distend high temperatures.

Features

- Tube I.D. 1/4" up to 1"
- Pressure rating Vacuum up to 3,500psi (276 bar)
- Min Bend radius 1.25 inch (32 mm)
- Conductive inner lining available

Inside Diameter		Number of Braids	Maximum Working Pressure		Minimum Bend Radius		Outside Diameter		Burst Pressure	
inch	mm		psi	bar	inch	mm	inch	mm	psi	bar
1/4	6.35	2	3500	241	1.0	26	0.57	14.48	14,000	965
3/8	8.65	2	3000	207	1.6	40	0.69	17.53	12,000	827
1/2	12.70	2	1800	124	2.5	64	0.85	21.59	7,200	496
3/4	19.05	2	1400	97	4.3	108	1.12	28.45	5,600	386



Hose Cover Color Code:



Materials of Construction

Part	Material
Tube	PTFE
Inner Braid	Fiberglass
Outer Braid	SST 304
External Cover	Silicone
End Connectors	SST 316L

THV Series - Multiple Layered Conductive PTFE Core

General

Smooth carbon PTFE core, fiberglass braid, insulating ceramic wrap layer, SS braid with a silicone cover. The Silicone cover protects the braid from particles or other external contamination and distend high temperatures.

Features

- Tube I.D. 3/8" up to 3/4"
- Pressure rating Vacuum up to 750 psi (51.72 bar)
- Min Bend radius 0.79 inch (20.06 mm)
- Carbon black PTFE core tube

Inside Diameter		Number of Braids (#)	Maximum Working Pressure		Static Minimum Bend Radius		Outside Diameter		Burst Pressure		Weight Per Foot (LBS)	Weight Per Meter (KG)
inch	mm		psi	bar	inch	mm	inch	mm	psi	bar		
3/8	8.83	2	750	52	2.8	7.0	0.79	19.99	3000	207	0.27	0.41
1/2	12.64	2	750	52	4.3	108	0.96	24.38	3000	207	0.34	0.50
3/4	19.11	2	500	34	6.5	165	1.27	32.13	2000	138	0.48	0.71



Hose Cover Color Code:

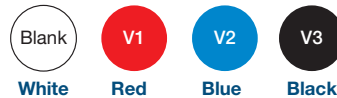

Materials of Construction

Part	Material
Tube	Carbon black PTFE
Inner Braid	Fiberglass
Insulating Layer	Ceramic wrap
Outer Braid	SST 304
External Cover	Silicone
End Connectors	SST 316L

Cover Options



Fire Insulation Jacket

High temperature insulation of the hose exterior is available by adding an insulated protective jacket. The jacket consists of braided fiberglass insulation, covered and saturated with Silicone rubber that is then installed over the corrugated hose and sealed. The Fire jacket can also be used to prevent ambient heat from being conveyed to the media or to reduce media heat loss.

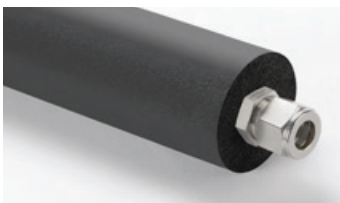

Thermal Insulation Cover

Thermal insulation of the hose exterior by adding a thermal insulation cover. Reduces heat loss of media by decreasing conduction and convection heat exchanges with the environment.



Aerogel Thermal Insulation

Highly efficient insulation material for extreme temperatures. Available in 2, 3 or 5 layers. For additional data, please contact your local representative.

PTFE Hoses - Ordering Information

OPTIONAL

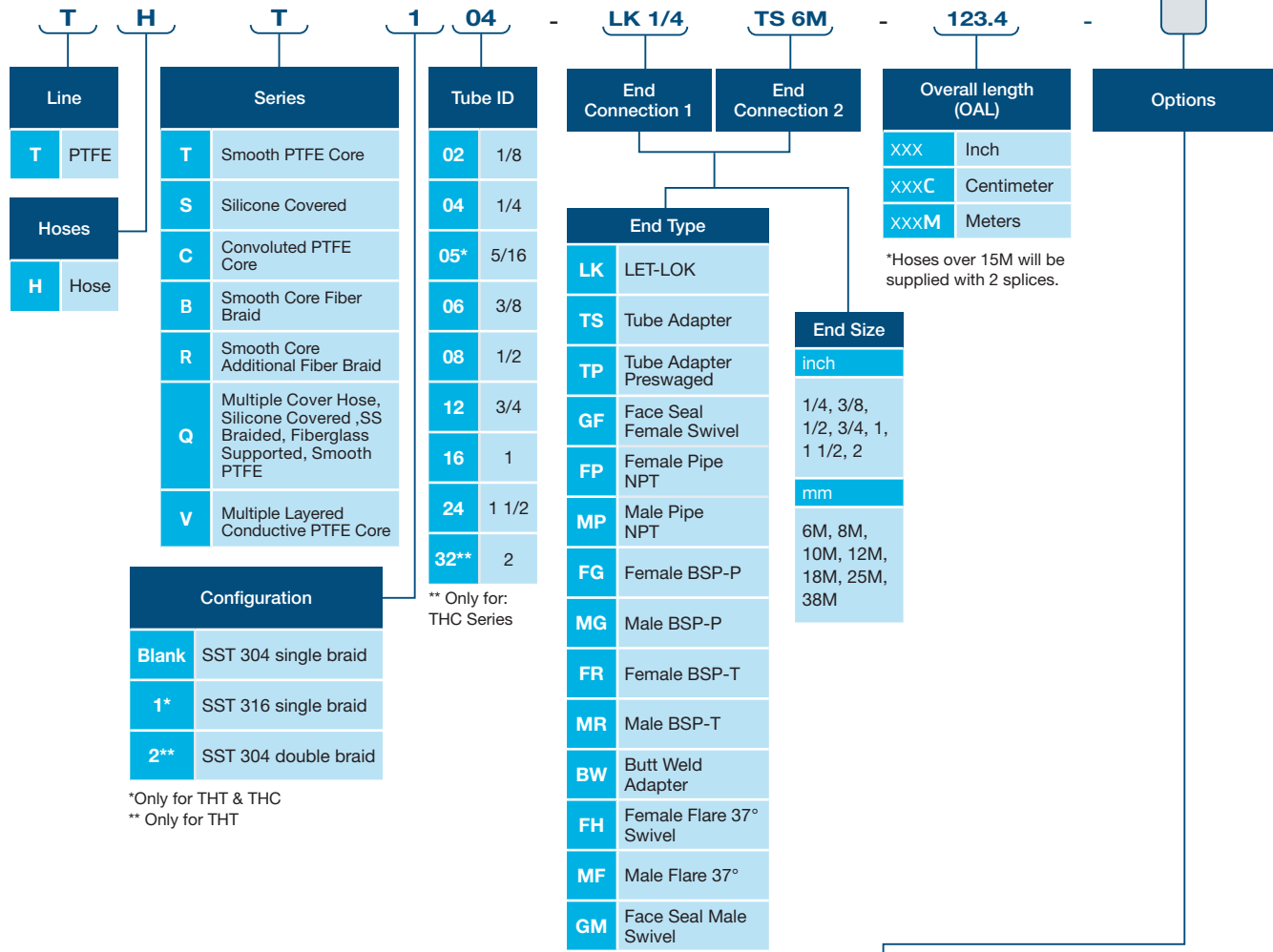

Configuration	
Blank	SST 304 single braid
1*	SST 316 single braid
2**	SST 304 double braid

*Only for THT & THC
** Only for THT

Hose Cover Color ⁽¹⁾		Certification	Internal Lamina	Outer Cover	Tagging			
Blank	White	EC ECE R110 ⁽²⁾ <small>(2) Only for: THT08-TS12MTS12M-XXX-ECC</small>	C Conductive Carbon Lining	J Insulating Jacket	M	Metal Tag	None	On One End
V1	Red			R Protective Cover	P	Plastic Tag	B	Both Ends
V2	Blue			X Anti Whip External Safety Cable				
V3	Black			D Aerogel Insulation ⁽³⁾				

(1) Only for THS, THQ and THV

(2) Please indicate number of layers (i.e. D2, D3, D5)

Warning!

The system designer and user have the sole responsibility for selecting products suitable for their special application requirements, ensuring their safe and trouble-free installation, operation, and maintenance. Application details, material compatibility and product ratings should all be considered for each selected product. Improper selection, installation or use of products can cause property damage or personal injury.



HAM-LET RUBBER HOSES



HAM-LET Rubber Hoses

General

Our RHG rubber hoses are designed for pneumatic and hydraulic applications, automotive industry, air systems and general industrial maintenance.

No Silicone is used during hose production.

RHG Hoses are to be used with HAM-LET HOSE END™ connectors.

* For HAM-LET HOSE END™ variety, see Rubber hoses components chapter.

Testing & Packing

All Hose assemblies are Hydrostatically tested to 1.5xMWP. All Hose assemblies are packed individually in a plastic bag, end connections are capped.

Features

- RUBBER core with all stainless steel or brass end connections assemblies per EN 16643:2016
- Available in 5 colors: Black, Blue, Red, Green and Yellow
- Easy to clean, drains easily
- True I.D.
- LET-LOK, ONE-LOK, NPT, BSPT, BSPP and SAE 37° Flare end connections
- ID Sizes: ¼" up to 1"
- Minimum bend radius 2.56 inch (65mm)
- Max. pressure 300 psi (20.7 bar), safety factor 1 to 4
- Working temperature: -40° ~ +190° F (-40° ~ + 99°C)
- Inner tube oil & heat resistant synthetic rubber (RMA Class A high oil resistance)
- Cover weather, abrasion & oil resistant Nitrile synthetic rubber (RMA Class B medium-high oil resistance)
- External layer has excellent abrasion, weather condition and oil resistance. Flame resistance meets MSHA standards
- Nonconductive (R > 1MΩ/inch at 1000 V DC)

RHG Series - Smooth Rubber Core Synthetic Braided Hose

Inside Diameter		Maximum Working Pressure		Minimum Bend Radius		Outside Diameter		Burst Pressure		Weight Per Foot	Weight Per Meter
inch	mm	psi	bar	inch	mm	inch	mm	psi	bar	lbs	kg
1/4	6.35	300	20.7	2.56	65	0.54	13.7	1,200	82.7	0.09	0.13
3/8	9.53	300	20.7	2.95	75	0.69	17.5	1,200	82.7	0.14	0.21
1/2	12.7	300	20.7	5.12	130	0.81	20.6	1,200	82.7	0.17	0.25
5/8	15.88	300	20.7	5.91	150	0.93	23.6	1,200	82.7	0.2	0.30
3/4	19.05	300	20.7	7.09	180	1.07	27.2	1,200	82.7	0.26	0.39
1	25.4	300	20.7	8.0	203	1.34	34.0	1,200	82.7	0.34	0.51

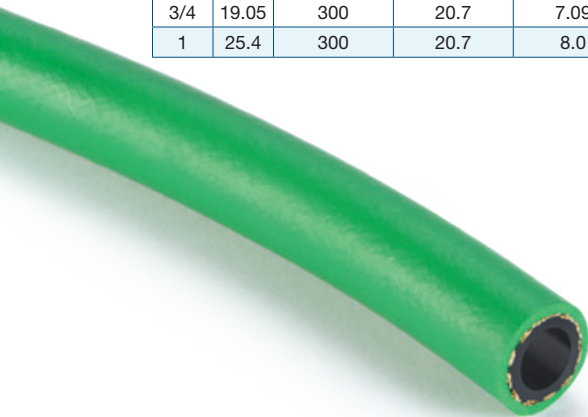

Materials of Construction

Part	Material
Tube	Nitrile synthetic rubber
Braid	Single Fiber Braid
External Cover	Nitrile Synthetic Rubber
End Connections	SST 316L

Hose Cover Color Code:



RUBBER HOSES - ORDERING INFORMATION

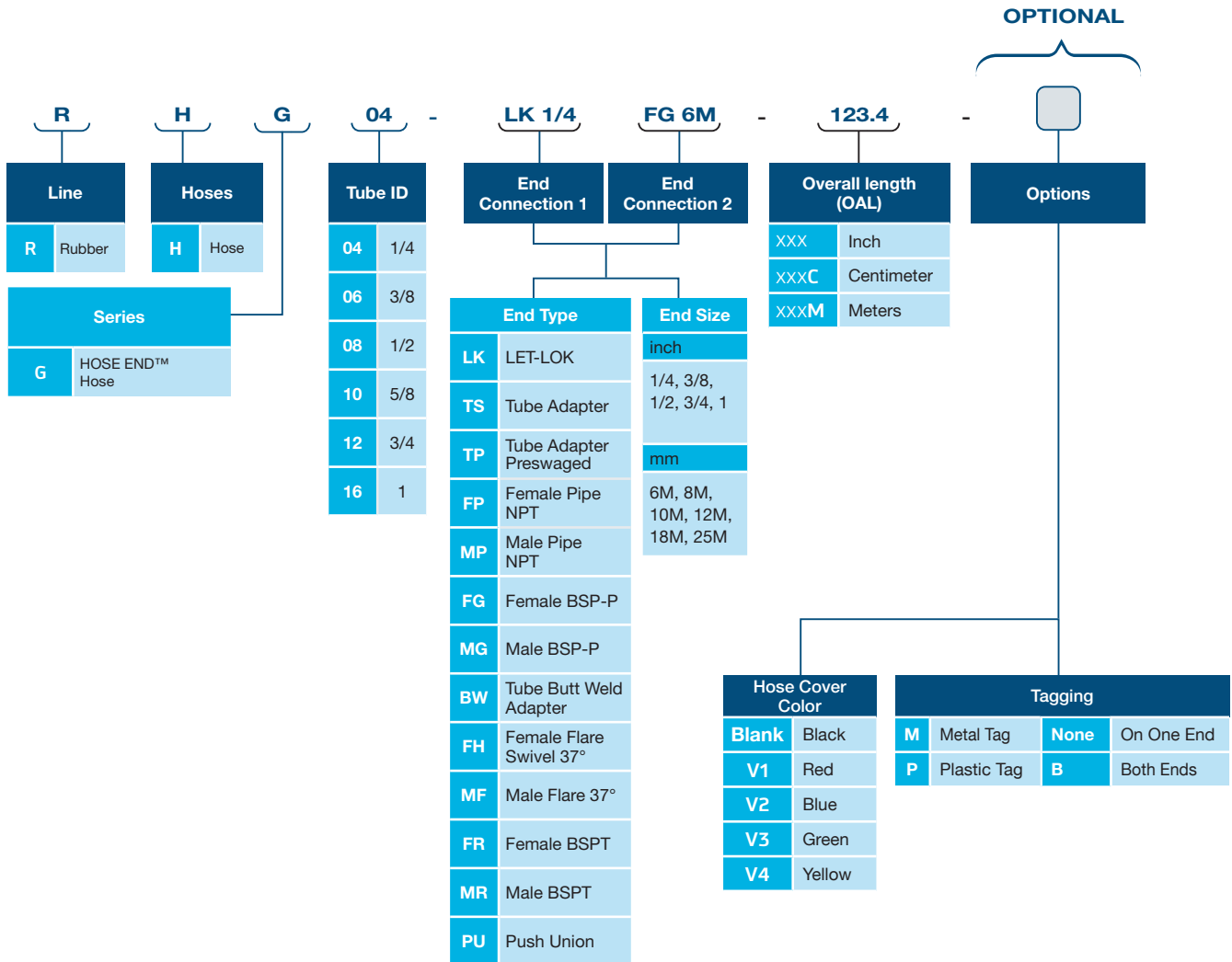

* For POP geometry add "P" before end type
Example: RHG04-PLK1/4PLK1/4-123.4

Warning!

The system designer and user have the sole responsibility for selecting products suitable for their special application requirements, ensuring their safe and trouble-free installation, operation, and maintenance. Application details, material compatibility and product ratings should all be considered for each selected product. Improper selection, installation or use of products can cause property damage or personal injury.

RUBBER HOSES COMPONENTS | FITTINGS

BULK RUBBER HOSES

Available for ordering as:

- Cut length, Min. 164 feet (50 meter)
- Reel of fixed length 500 feet (152.4 meter) for all sizes (maximum 4 pieces in a reel, 10 feet minimum)

HOW TO ORDER

R		H		G		04		M		V1			
Line		Hoses		Series		Tube ID		Bulk Hoses		Hose Cover Color		Length	
R	Rubber	H	Hose	G	HOSE END™ Hose	04	1/4	M	Bulk	Blank	Black	Blank	Meter
						06	3/8			V1	Red	FT	Feet
						08	1/2			V2	Blue		
						10	5/8			V3	Green		
						12	3/4			V4	Yellow		
						16	1			V5	Grey		

Maximum Divisions Per Meter	
Meter	Pieces
50-79	2
80-100	3
100>	4
152.4	4



For a complete range of end connections see the following pages, or the UCT catalog.

Warning!

The system designer and user have the sole responsibility for selecting products suitable for their special application requirements, ensuring their safe and trouble-free installation, operation, and maintenance. Application details, material compatibility and product ratings should all be considered for each selected product. Improper selection, installation or use of products can cause property damage or personal injury.

HAM-LET NYLON HOSES

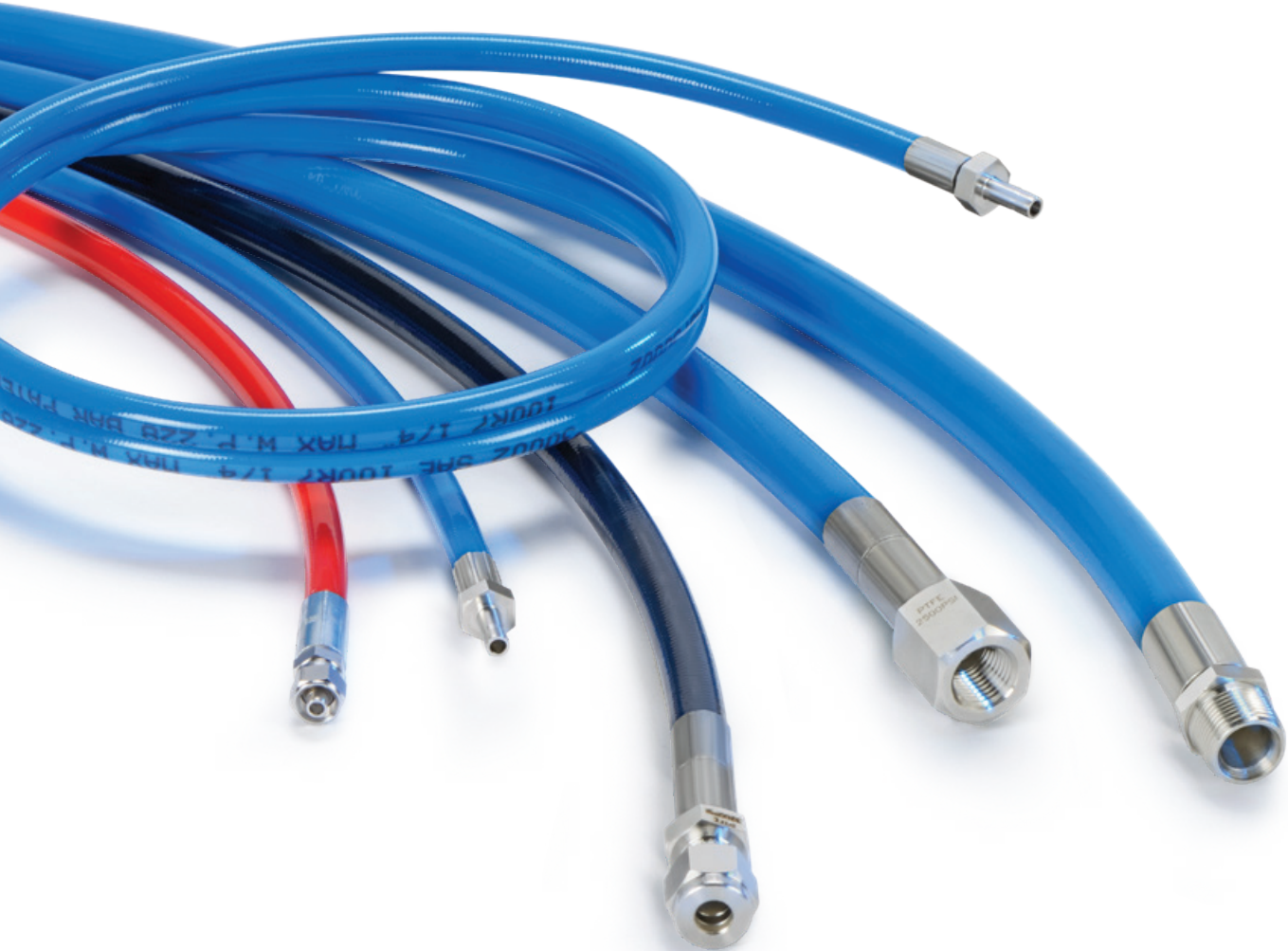

HAM-LET NYLON HOSES

General

Our nylon Hoses are designed for a wide range of applications including Automotive, CNG gas, Fuel and Oil transfer, Hydraulic lines, Instrumentation, Compressed air and much more.

Variable length, lightweight, excellent flexibility, durability for increased number of cycles, chemical and corrosion resistance and very high working pressure making Ham-Let nylon hoses a great solution for your needs.

Testing & Packing

All hoses are Hydrostatically tested to 1.5 MWP.

All hoses are packed individually in a plastic bag, end connections are capped.

Features

- ID sizes 1/4" to 1"
- Pressure rating: 13.5psi Vacuum to 5000psi (345 bar)
- Min Bend radius 1.8inch (45mm)
- On request twin-line or multi-line construction available
- Electrical resistance lower than 0.12 MOhm/m according to ISO 8031
- Working temperature -40° to 180° F (-40° to +82°C)
- External cover is micro perforated anti abrasion RED Polyurethane
- Meet or exceed ISO 15500-17 and SAE 100R8 standards

NHG Series - Nylon reinforced Hose for CNG gas

Inside Diameter		Number of Braids	Maximum Working Pressure		Dynamic Minimum Bend Radius		Outside Diameter		Burst Pressure		Weight Per Foot	Weight Per Meter
inch	mm		(#)	(psi)	bar	inch	mm	inch	mm	psi		
1/4	6.35	2	5,000	345	1.8	45	0.49	12.5	20,000	1,379	0.07	0.11
3/8	9.53	2	5,000	345	3.0	75	0.65	16.5	20,000	1,379	0.10	0.15
1/2	12.7	2	5,000	345	3.7	95	0.87	22	20,000	1,379	0.17	0.25
3/4	19.05	2	5,000	345	7.3	185	1.14	29	20,000	1,379	0.24	0.36
1	24.4	2	5,000	345	9.1	230	1.52	38.5	20,000	1,379	0.34	0.51



Materials of Construction

Part	Material
Tube	Electrically Conductive Polyamide
Braid	Two Textile Fibers
External Cover	Polyurethane
End Connections	SST 316L

NYLON HOSES - ORDERING INFORMATION

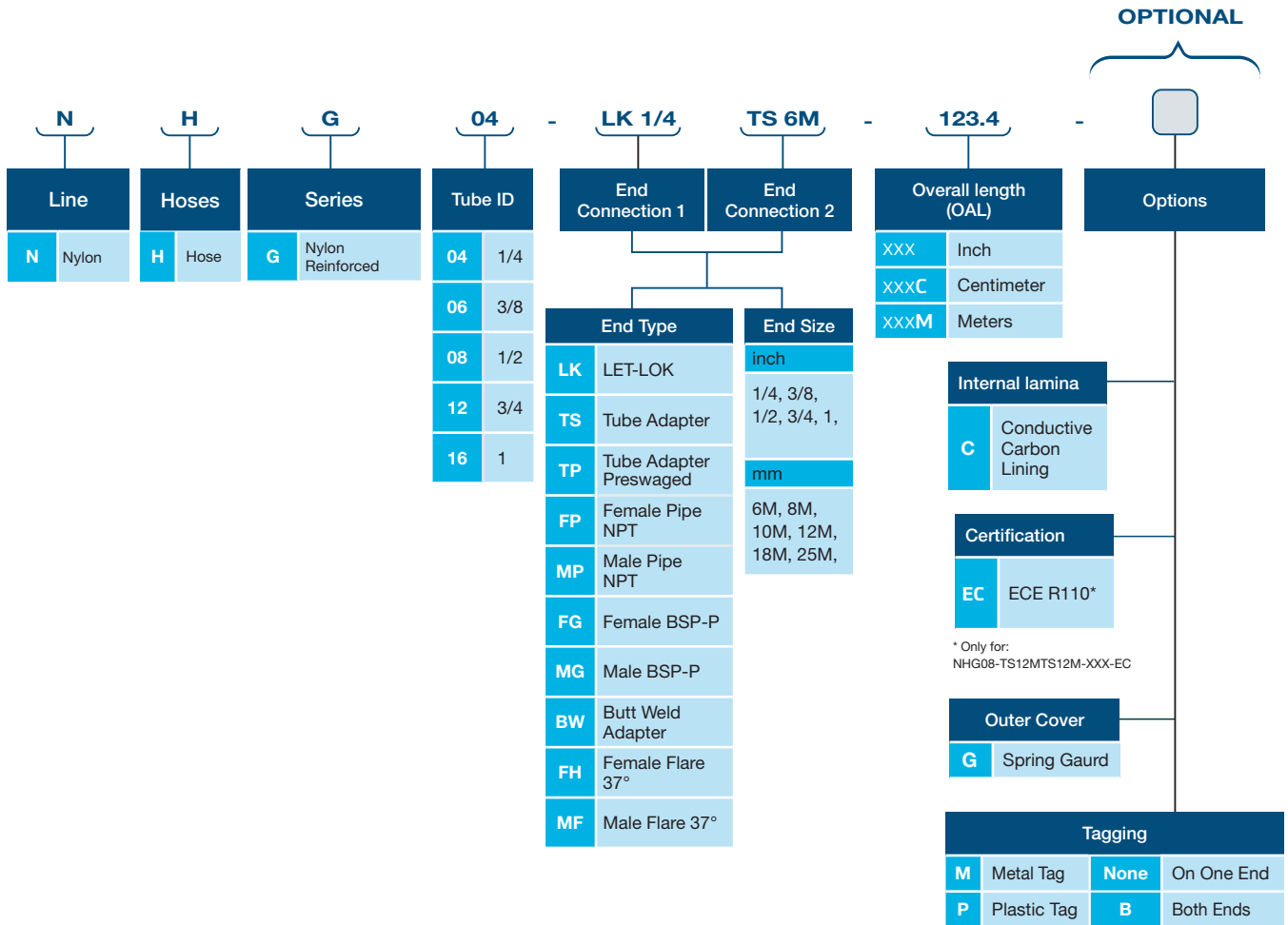

Warning!

The system designer and user have the sole responsibility for selecting products suitable for their special application requirements, ensuring their safe and trouble-free installation, operation, and maintenance. Application details, material compatibility and product ratings should all be considered for each selected product. Improper selection, installation or use of products can cause property damage or personal injury.



HAM-LET METAL HOSES COMPONENTS

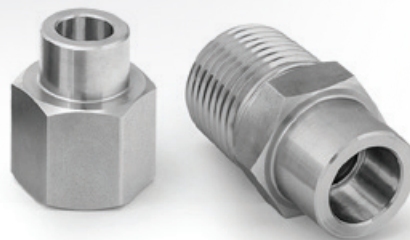

METAL HOSES COMPONENTS | FITTINGS

LET-LOK TUBE FITTINGS

768LW

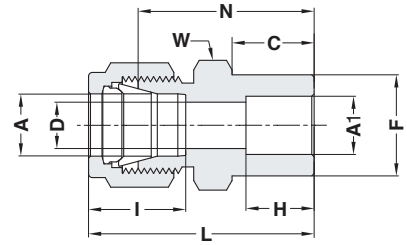
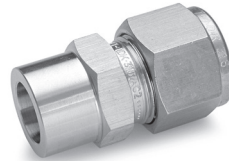

Ordering Information (INCH)	A Tube O.D		A1 Hose O.D		C		D		W Hex. Flat	F		H		I		L		N	
	inch	mm	inch	mm	inch	mm	inch	mm	inch	inch	mm	inch	mm	inch	mm	inch	mm	inch	mm
768LW _ 1/8 X 1/8	1/8	3.17	1/8	3.17	0.34	8.64	0.09	2.28	7/16	0.31	7.87	0.25	6.35	0.5	12.7	1.14	28.96	0.88	22.35
768LW _ 1/4 X 1/4	1/4	6.35	1/4	6.35	0.41	10.4	0.19	4.8	1/2	0.44	11.2	0.31	7.9	0.6	15.2	1.32	33.53	1.03	26.16
768LW _ 1/4 X 3/8	1/4	6.35	3/8	9.52	0.47	11.9	0.19	4.8	5/8	0.62	15.8	0.38	9.65	0.6	15.2	1.41	35.96	1.13	28.6
768LW _ 3/8 X 1/4	3/8	9.52	1/4	6.35	0.41	10.4	0.19	4.8	5/8	0.44	11.2	0.31	7.9	0.66	16.8	1.42	36.06	1.13	28.7
768LW _ 3/8 X 3/8	3/8	9.52	3/8	9.52	0.47	11.9	0.28	7.1	5/8	0.62	15.8	0.38	9.65	0.66	16.8	1.48	37.6	1.19	30.23
768LW _ 1/2 X 1/4	1/2	12.7	1/4	6.35	0.41	10.4	0.19	4.8	13/16	0.44	11.2	0.31	7.9	0.5	12.7	1.58	40.6	1.18	30
768LW _ 1/2 X 1/2	1/2	12.7	1/2	12.7	0.47	11.9	0.41	10.4	13/16	0.75	19.05	0.5	12.7	0.9	22.9	1.62	41.15	1.22	31
768LW _ 3/4 X 3/4	3/4	19.05	3/4	19.05	0.47	11.9	0.62	15.8	1 1/16	1.05	26.7	0.56	14.2	0.96	24.4	1.71	43.43	1.31	33.28
768LW _ 1 X 1	1	25.4	1	25.4	0.56	14.2	0.88	22.35	1 3/8	1.36	34.5	0.75	19.2	1.23	31.2	2.07	52.58	1.59	40.4
768LW _ 1-1/4 X 1-1/4	1-1/4	32	1-1/4	32	0.66	16.9	1.09	27.7	1 3/4	1.73	44	0.75	19.2	1.62	41.2	2.76	70.1	1.89	48
768LW _ 1-1/2 X 1-1/2	1-1/2	38.35	1-1/2	38.35	0.71	18.1	1.34	34	2 1/8	1.97	50	0.9	22.9	1.97	50	3.18	80.78	2.11	53.6
768LW _ 2 X 2	2	51.15	2	51.15	1	25.4	1.81	46	2 3/4	2.48	63	1.19	30.4	2.66	67.6	4.16	105.84	2.69	68.5

Ordering Information (METRIC)	A Tube O.D	A1 Hose O.D	C	D	W Hex. Flat	F	H	I	L	N
	mm	inch	mm	mm	mm	mm	mm	mm	mm	mm
768LW _ 6MM X 1/4	6	1/4	10.4	4.8	14	11.2	7.9	15.3	32.8	25.4
768LW _ 8MM X 1/4	8	1/4	10.4	4.8	15	11.2	7.9	16.2	35	27.5
768LW _ 10MM X 3/8	10	3/8	11.9	7.1	18	15.8	9.65	17.2	38.6	31
768LW _ 12MM X 1/2	12	1/2	11.9	9.5	22	19.05	12.7	22.8	41.1	31
768LW _ 18MM X 3/4	18	3/4	11.9	15.1	27	26.7	14.2	24.4	43.5	33.4
768LW _ 25MM X 1	25	1	14.2	21.8	35	34.5	19.2	31.3	52.7	40.4
768LW _ 38MM X 1-1/2	38	1-1/2	18.1	33.7	55	50	22.9	49.4	83.6	56

ONE-LOK ORDERING INFORMATION

ONE-LOK fitting part numbers are constructed from symbols that identify the type of material and size of the fitting.

The ONE-LOK part numbering system is the same as our LET-LOK Tube Fittings, with the exception that you add an "H" between the prefix number and the "L" to designate the one ferrule design.

768HLW

Fitting type
(male connector)

SS

SS = Stainless Steel

1/4

x

1/4

Tube O.D.
The O.D. size is always the first to described

1/4 O.D. Hose

METAL HOSES COMPONENTS | FITTINGS

TUBE ADAPTER

739 LW

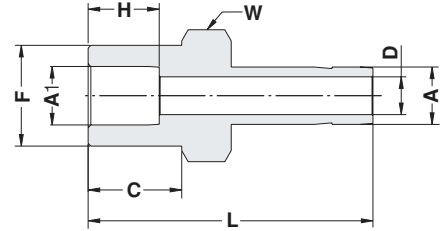
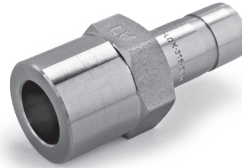

Ordering Information (INCH)	A Tube O.D		A1		C		D		W Hex. Flat		F		H		L	
	inch	mm	inch	mm	inch	mm	inch	mm	inch	mm	inch	mm	inch	mm	inch	mm
739LW _ 1/4 X 1/4	1/4	6.35	1/4	6.35	0.41	10.4	0.17	4.2	1/2	0.44	11.2	0.31	7.9	1.25	31.7	
739LW _ 1/4 X 3/8	1/4	6.35	3/8	9.52	0.47	11.9	0.17	4.2	5/8	0.62	15.8	0.38	9.7	1.35	34.3	
739LW _ 3/8 X 3/8	3/8	9.52	3/8	9.52	0.47	11.9	0.28	7.11	5/8	0.62	15.8	0.38	9.7	1.42	36.7	
739LW _ 3/8 X 1/2	3/8	9.52	1/2	12.7	0.47	11.9	0.28	7.11	13/16	0.75	19.05	0.5	12.7	1.45	36.9	
739LW _ 1/2 X 1/2	1/2	12.7	1/2	12.7	0.47	11.9	0.39	9.91	13/16	0.75	19.05	0.5	12.7	1.67	42.42	
739LW _ 3/4 X 3/4	3/4	19.05	3/4	19.05	0.47	11.9	0.59	15	1-1/16	1.05	26.7	0.56	14.2	1.73	43.94	
739LW _ 1 X 3/4	1	25.4	3/4	19.05	0.74	11.9	0.8	20.3	1-1/16	1.05	26.7	0.56	14.2	2.12	54	
739LW _ 3/4 X 1	3/4	19.05	1	25.4	0.74	11.9	0.59	15	1-3/8	1.36	34.5	0.76	19.2	2	50.8	
739LW _ 1 X 1	1	25.4	1	25.4	0.74	11.9	0.8	20.3	1-3/8	1.36	34.5	0.76	19.2	2.33	59.2	
739LW _ 1-1/4 X 1-1/4	1-1/4	31.75	1-1/4	31.75	0.66	16.9	1.02	26	1-3/4	1.73	44	0.76	19.2	2.94	74.7	
739LW _ 1-1/2 X 1-1/2	1-1/2	38.1	1-1/2	38.1	0.71	18.1	1.24	31.6	2-1/8	1.97	50	0.9	22.9	3.54	90	

Ordering Information (METRIC)	A Tube O.D		A1	C	D	W Hex. Flat		F	H	L
	mm	inch	mm	mm	mm	inch	mm	mm	mm	mm
739LW _ 6MMX 1/4	6	1/4	10.4	4	1/2	-	11.2	7.9	31.7	
739LW _ 8MM X 1/4	8	1/4	10.4	5.6	-	14	11.2	7.9	35.3	
739LW _ 10MMX 1/4	10	1/4	10.4	4.8	9/16	-	11.2	7.9	34	
739LW _ 10MMX 3/8	10	3/8	11.9	7.1	5/8	-	15.8	9.7	36	
739LW _ 12MM X 1/2	12	1/2	11.9	8.8	13/16	-	19.05	12.7	42.5	
739LW _ 18MM X 3/4	18	3/4	11.9	13.9	-	27	26.7	14.2	46.2	
739LW _ 25MM X 1	25	1	11.9	19.8	-	35	34.5	19.2	58.7	
739LW _ 38MM X 1-1/2	38	1-1/2	18.1	31.6	-	55	50	22.9	90	

HAM-LET METAL HOSES COMPONENTS | FITTINGS

MALE NPT IP98TS MP

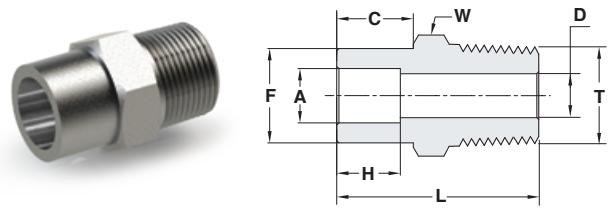

Ordering Information (INCH)	A Tube O.D		T Male NPT	C		D		W Hex. Flat	F		H		L	
	inch	mm	inch	inch	mm	inch	mm	inch	inch	mm	inch	mm	inch	mm
IP98TS04H04 TUBE 1/4X1/4	1/4	6.35	1/4	0.31	8	0.19	4.8	9/16	0.44	11.2	0.28	7.1	1.15	29.2
IP98TS04H06 TUBE 1/4X3/8	1/4	6.35	3/8	0.41	10.4	0.38	9.65	11/16	0.44	11.2	0.28	7.1	1.25	31.7
IP98TS06H06 TUBE 3/8X3/8	3/8	9.52	3/8	0.41	10.5	0.28	7.1	11/16	0.62	15.8	0.31	7.9	1.25	31.8
IP98TS06H04 TUBE 3/8X1/4	3/8	9.52	1/4	0.43	11	0.28	7.1	5/8	0.62	15.8	0.31	7.9	1.25	31.8
IP98TS06H08 TUBE 3/8X1/2	3/8	9.52	1/2	0.41	10.5	0.28	7.1	7/8	0.62	15.8	0.31	7.9	1.47	37.3
IP98TS08H06 TUBE 1/2X3/8	1/2	12.7	3/8	0.47	11.9	0.38	9.65	3/4	0.73	18.5	0.38	9.7	1.28	32.5
IP98TS04H08 TUBE 1/4X1/2	1/4	6.35	1/2	0.41	10.4	0.67	11.9	7/8	0.44	11.2	0.31	7.9	1.47	37.3
IP98TS08H08 TUBE 1/2X1/2S	1/2	12.7	1/2	0.47	12	0.41	10.4	7/8	0.73	18.5	0.38	9.7	1.53	38.9
IP98TS08H12 TUBE 1/2X3/4	1/2	12.7	3/4	0.47	11.9	0.41	10.4	1-1/16	0.75	19.05	0.5	12.7	1.61	41
IP98TS12H12 TUBE 3/4X3/4	3/4	19.05	3/4	0.47	11.9	0.62	15.75	1-1/16	1.05	26.7	0.44	11.2	1.56	39.6
IP98TS16H12 TUBE 1X3/4	1	25.4	3/4	0.56	14.2	0.62	15.75	1-3/8	1.36	34.5	0.62	15.7	1.78	45.14
IP98TS16H16 TUBE 1X1	1	25.4	1	0.56	14.2	0.86	21.8	1-3/8	1.36	34.5	0.62	15.7	1.97	50.04
IP98TS20H20 TUBE 1-1/4X1-1/4	1-1/4	31.75	1-1/4	0.66	16.9	1.09	27.7	1-3/4	1.73	44	0.75	19.2	2.18	55.5
IP98TS24H24 TUBE 1-1/2X1-1/2	1-1/2	38.1	1-1/2	0.71	18.1	1.34	34	2-1/8	1.97	50	0.90	22.9	2.44	62
IP98TS32H32 TUBE 2X2	2	50.8	2	1	25.4	1.81	45.97	2-3/4	2.53	63	1.19	30.4	3	76.2

769 LW TUBE SOCKET WELD ELBOW

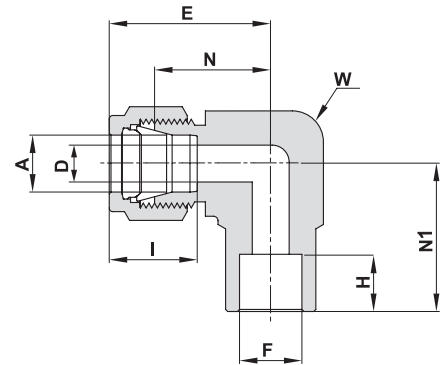

TUBE (INCH)

Ordering Information	A Tube O.D.		F Tube O.D.		D		W Wrench Flat		N		H		E		N1		I	
	inch	mm	inch	mm	inch	mm	inch	mm	inch	mm	inch	mm	inch	mm	inch	mm	inch	mm
769LW _ 1/4 X 1/4	1/4	6.35	1/4	6.35	.19	4.82	1/2	12.7	.77	19.60	.31	7.87	1.06	26.98	.77	19.60	.60	15.2
769LW _ 3/8 X 3/8	3/8	9.52	3/8	9.52	.28	7.11	5/8	15.9	.91	23.11	.38	9.65	1.20	30.98	.91	23.11	.66	16.8
769LW _ 1/2 X 1/2	1/2	12.70	1/2	12.70	.41	10.41	15/16	23.8	1.02	25.90	.50	12.70	1.42	36.06	1.02	25.90	.90	22.9
769LW _ 3/4 X 3/4	3/4	19.05	3/4	19.05	.62	15.74	1 1/16	27.0	1.17	29.71	.56	14.22	1.57	39.87	1.17	29.71	.96	24.4
769LW _ 1 X 1	1	25.40	1	25.40	.88	22.35	1 3/8	34.9	1.45	36.83	.75	19.05	1.93	49.02	1.45	36.83	1.23	31.2

Designation:
Marking LW on Flat

HAM-LET METAL HOSES COMPONENTS | FITTINGS

MALE BSPP

IP98TS MG

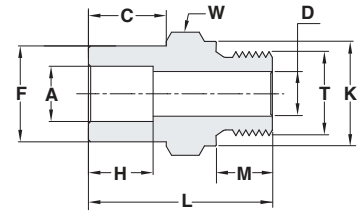

Ordering Information (INCH)	A Tube O.D		T Male BSPP	C		D		W Hex. Flat	F		H		L		K		M	
	inch	mm	inch	inch	mm	inch	mm	inch	inch	mm	inch	mm	inch	mm	inch	mm	inch	mm
IP98TS04H04G 1/4X1/4 BSPP	1/4	6.35	1/4	0.41	10.4	0.19	4.8	3/4	0.48	12.2	0.28	7.1	1.19	30.2	0.71	18	0.44	11.2
IP98TS06H06G 3/8X3/8 BSPP	3/8	9.52	3/8	0.67	11.9	0.28	7.1	7/8	0.62	15.8	0.38	9.65	1.3	33	0.86	21.8	0.44	11.2
IP98TS08H08G 1/2X1/2 BSPP	1/2	12.7	1/2	0.67	11.9	0.41	10.4	1-1/16	0.73	18.5	0.38	9.7	1.47	37.4	1.02	26	0.56	14.2
IP98TS12H12G 3/4X3/4 BSPP	3/4	19.05	3/4	0.67	11.9	0.62	15.8	1-5/16	1.05	26.7	0.44	11.2	1.68	42.7	1.26	32	0.62	15.7
IP98TS16H16G 1X1 BSPP	1	25.4	1	0.56	14.2	0.78	19.8	1-5/8	1.36	34.5	0.75	19.2	1.88	47.75	1.53	39	0.72	18.3
IP98TS20H20G 1-1/4X1-1/4 BSPP	1-1/4	31.75	1-1/4	0.66	16.9	0.88	22.3	2-1/8	1.73	44	0.75	19.2	2.13	54.1	1.97	50	0.78	19.8
IP98TS24H24G 1-1/2X1-1/2 BSPP	1-1/2	38.1	1-1/2	0.71	18.1	1.24	31.6	2-1/4	1.97	50	0.9	22.9	2.49	63.25	2.16	55	0.87	22

FEMALE NPT

IP96TS FP

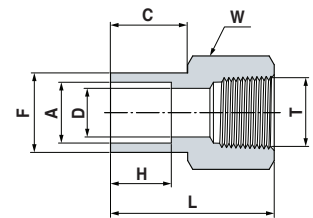

Ordering Information (INCH)	A Tube O.D		T Female NPT	C		D		W Hex. Flat	F		H		L	
	inch	mm	inch	inch	mm	inch	mm	inch	inch	mm	inch	mm	inch	mm
IP96TS04H04 TUBE 1/4X1/4	1/4	6.35	1/4	0.39	10	0.19	4.8	3/4	0.49	12.40	0.28	7.1	1.18	30
IP96TS06H06 TUBE 3/8X3/8	3/8	9.52	3/8	0.41	10.5	0.28	7.1	7/8	0.62	15.8	0.28	6.95	1.19	30.4
IP96TS06H04 TUBE 3/8X1/4	3/8	9.52	1/4	0.41	10.5	0.28	7.1	3/4	0.62	15.8	0.31	7.9	1.24	31.5
IP96TS08H08 TUBE 1/2X1/2	1/2	12.7	1/2	0.46	11.9	0.41	10.4	1-1/16	0.73	18.5	0.38	9.7	1.59	40.4
IP96TS12H12 TUBE 3/4X3/4	3/4	19.05	3/4	0.46	11.9	0.62	15.7	1-5/16	1.04	26.4	0.44	11.2	1.72	43.9
IP96TS16H16 TUBE 1X1	1	25.4	1	0.55	14.2	0.88	22.3	1-5/8	1.36	34.5	0.61	15.7	1.95	49.53
IP96TS24H24 TUBE 1-1/2X1-1/2	1-1/2	38.1	1-1/2	0.71	18.1	1.34	34	2-3/8	1.97	50.0	0.90	22.9	2.43	61.73

HAM-LET METAL HOSES COMPONENTS | FITTINGS

FEMALE BSPP

IP96TS FG

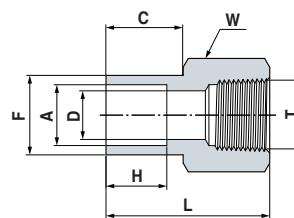

Ordering Information (INCH)	A Tube O.D		T Female BSPP	C		D		W Hex. Flat	F		H		L	
	inch	mm	inch	inch	mm	inch	mm	inch	inch	mm	inch	mm	inch	mm
IP96TS04H04G 1/4X1/4BSPP	1/4	6.35	1/4	0.41	10.4	0.22	5.5	3/4	0.48	12.2	0.28	7.1	1.18	30.2
IP96TS06H06G 3/8X3/8BSPP	3/8	9.52	3/8	0.41	10.5	0.26	6.5	15/16	0.62	15.8	0.38	9.65	1.18	30.0
IP96TS08H08G 1/2X1/2BSPP	1/2	12.7	1/2	0.47	11.9	0.28	7.1	1-1/16	0.78	18.5	0.38	9.7	1.5	38.1

TUBE BUTT WELD ADAPTER

IP93TBW BW

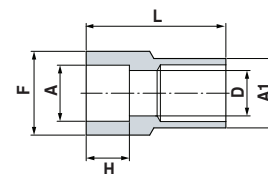

Ordering Information (INCH)	A Tube O.D		A1		D		F		H		L	
	inch	mm	inch	mm	inch	mm	inch	mm	inch	mm	inch	mm
IP93TBW04H04 HOSE END	1/4	6.35	1/4	6.35	0.18	4.75	0.48	12.2	0.28	7.1	1.26	32.2
IP93TBW08H04 HOSE END	1/4	6.35	1/2	12.7	0.18	4.8	0.5	12.7	0.28	7.1	1.22	31.2
IP93TBW06H04 HOSE END	1/4	6.35	3/8	9.52	0.18	4.8	0.48	12.2	0.28	7.1	1.18	30.2
IP93TBW06H06 HOSE END	3/8	9.52	3/8	9.52	0.30	7.74	0.59	15.2	0.311	7.9	1.31	33.5
IP93TBW04H08 HOSE END	1/2	12.7	1/4	6.35	0.41	10.4	0.74	19	0.38	9.7	1.34	34.1
IP93TBW08H08 HOSE END	1/2	12.7	1/2	12.7	0.40	10.21	0.72	18.5	0.38	9.7	1.53	39.1
IP93TBW12H12 HOSE END	3/4	19.05	3/4	19.05	0.65	16.56	1.03	26.4	0.44	11.2	1.51	38.5
IP93TBW16H12 HOSE END	3/4	19.05	1	25.4	0.61	22.1	1.03	26.4	0.44	11.2	1.53	39
IP93TBW16H16 HOSE END	1	25.4	1	25.4	0.87	15.7	1.35	34.5	0.61	15.7	1.71	43.5
IP93TBW20H20 HOSE END	1-1/4	31.75	1-1/4	31.75	1.07	27.23	1.73	44	0.75	19.2	1.82	46.22
IP93TBW16H24 HOSE END	1-1/2	38.1	1	25.4	1.31	33.27	1.96	50	0.90	22.9	2.12	53.85
IP93TBW24H24 HOSE END	1-1/2	38.1	1-1/2	38.1	1.31	33.27	1.96	50	0.90	22.9	1.89	48
IP93TBW32H32 HOSE END	2	50.8	2	50.8	0.78	45.2	2.48	63	1.19	30.4	2.13	54.2

HAM-LET METAL HOSES COMPONENTS | FITTINGS

LONG BUTT WELD ADAPTER

IP93TBW LW

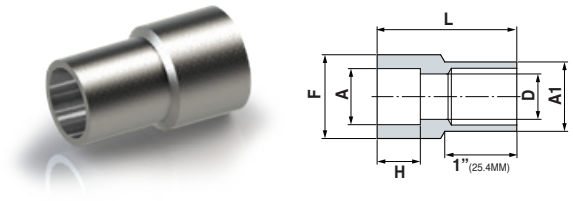

Ordering Information (INCH)	A Tube O.D		A1		D		F		H		L	
	inch	mm	inch	mm	inch	mm	inch	mm	inch	mm	inch	mm
IP93TBW04H04 HOSE END L=1	1/4	6.50	1/4	6.35	0.18	4.57	0.48	12.2	0.28	7.1	1.52	38.6
IP93TBW06H06 HOSE END L=1	3/8	9.67	3/8	9.52	0.30	7.74	0.60	15.2	0.31	7.9	1.57	39.9
IP93TBW08H08 HOSE END L=1	1/2	12.85	1/2	12.7	0.40	10.21	0.73	18.5	0.38	9.7	1.79	45.5
IP93TBW12H12 HOSE END L=1	3/4	19.20	3/4	19.05	0.65	16.56	1.04	26.4	0.44	11.2	1.77	44.9
IP93TBW16H12 HOSE END L=1	3/4	19.20	1	25.4	0.87	22.1	1.04	26.4	0.44	11.2	1.79	45.4
IP93TBW16H24 HOSE END L=1	1-1/2	38.27	1	25.4	0.87	22.1	1.97	50.0	0.90	22.9	2.37	60.25

MALE JIC 37° FLARE

748HFW

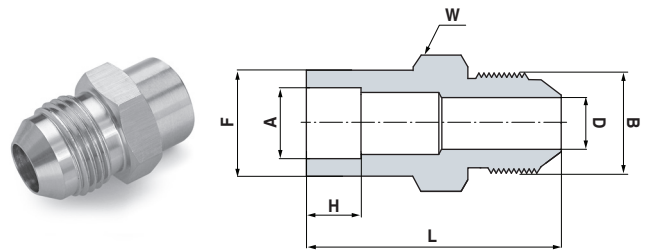

Ordering Information (INCH)	A Tube O.D		B UN	D		F		H		L		W Hex flat
	inch	mm	inch	inch	mm	inch	mm	inch	mm	inch	mm	inch
748HFW _ 1/4 X 1/4	1/4	6.35	7/16-20	0.17	4.4	0.48	12.2	0.32	7.9	1.18	29.9	1/2
748HFW _ 3/8 X 3/8	3/8	9.52	9/16-18	0.29	7.5	0.62	15.8	0.39	9.65	1.28	32.45	5/8
748HFW _ 1/2 X 1/2	1/2	12.7	3/4-16	0.39	9.9	0.75	19.05	0.51	12.7	1.05	26.6	13/16
748HFW _ 3/4 X 3/4	3/4	19.05	1 1/16-12	0.60	15.5	1.05	26.7	0.57	14.2	1.78	45.2	1-1/8
748HFW _ 1 X 1	1	25.4	1 5/16-12	0.84	21.5	1.36	34.5	0.77	19.22	1.94	49.3	1-3/8
748HFW _ 1-1/4 X 1-1/4	1-1/4	31.75	1 5/8-12	1.07	27.5	1.73	44	0.77	19.2	2.15	54.5	1-3/4
748HFW _ 1-1/2 X 1-1/2	1-1/2	38.1	1 7/8-12	1.31	33	1.97	50	0.92	22.9	2.48	63	2-1/8
748HFW _ 2 X 2	2	50.8	2 1/2-12	1.78	45	2.48	63	1.22	30.4	3.07	77.9	2-5/8

HAM-LET METAL HOSES COMPONENTS | FITTINGS

MALE SWIVEL FACE SEAL GM

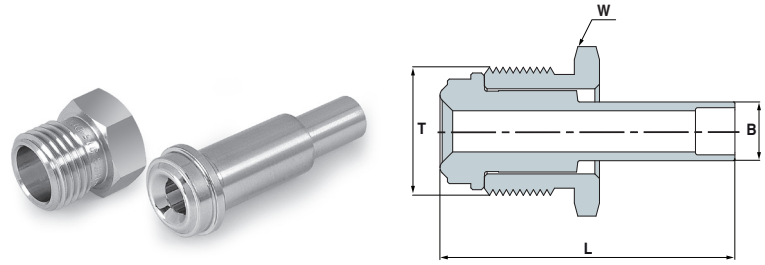

End Connection Type	Ordering Information	Hose I.D. Weld Pipe	End Connection	T Thread-inch	W inch	L mm	B mm
Male Face Seal Swivel	V-GSW-1/4-W-H	1/4	1/4	9/6-18	5/8	33.3	8.9
	P-NM-1/4 NUT MALE						
Male Face Seal Swivel	V-GM-3/8-W-H	1/4	1/2	7/8-14	15/16	38.1	9.52
	P-NM-1/2 NUT MALE						
Male Face Seal Swivel	V-GM-1/2-W-H	3/8	1/2	7/8-14	15/16	38.1	12.7
	P-NM-1/2 NUT MALE						
Male Face Seal Swivel	V-GSW-1/2-W-H	1/2	1/2	7/8-14	15/16	38.1	15.1
	P-NM-1/2 NUT MALE						
Male Face Seal Swivel	P-GSW-3/4-W-H	3/4	3/4	1 1/4-18	1-5/16	50.8	22.3
	P-NM-3/4 NUT MALE						
Male Face Seal Swivel	P-GSW-1"-W-H	1	1	1 1/2-20	1-5/8	56.4	30.2
	P-NM-1 NUT MALE						

FEMALE SWIVEL FACE SEAL GF

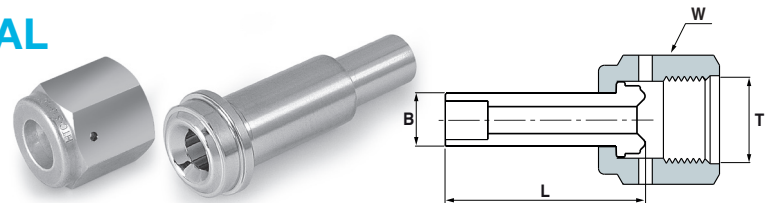

End Connection Type	Components Descriptions	Hose I.D. Weld Pipe	Face Seal	T Thread-inch	W inch	L mm	B mm
Female Face Seal Swivel	V-GSW-1/4-W-H	1/4	1/4	9/16-18	3/4	33.3	8.9
	P-NF-1/4 NUT FEMALE						
Female Face Seal Swivel	V-GM-3/8 -W-H	1/4	1/2	7/8-14	1-1/16	38.1	9.52
	P-NF-1/2 NUT FEMALE						
Female Face Seal Swivel	V-GM-1/2-W-H	3/8	1/2	7/8-14	1-1/16	38.1	12.7
	P-NF-1/2 NUT FEMALE						
Female Face Seal Swivel	V-GSW-1/2-W-H	1/2	1/2	7/8-14	1-1/16	38.1	15.1
	P-NF-1/2 NUT FEMALE						
Female Face Seal Swivel	P-GSW-3/4-W-H	3/4	3/4	1 1/4-18	1-1/2	50.8	22.3
	P-NF-3/4 NUT FEMALE						
Female Face Seal Swivel	P-GSW-1"-W-H	1	1	1 1/2-20	1-3/4	56.4	30.2
	P-NF-1 NUT FEMALE						
Female Face Seal Swivel	IP93TBW16H24 HOSE END	1 1/2	1	1 1/2-20	1-3/4	85.85	50
	P-GS-1"-W-H 0.065" W.T.						
	P-NF-1 NUT FEMALE						

HAM-LET METAL HOSES COMPONENTS | FITTINGS

FEMALE JIC 37° FLARE 746HFFW

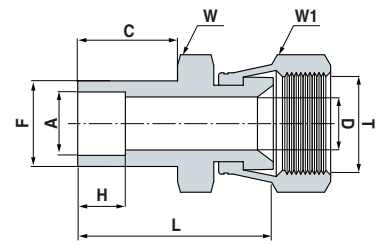

Ordering Information (INCH)	A Tube O.D.		T Female Size	C		D		W Hex. Flat	W1 Hex. Flat	F		H		L	
	inch	mm	inch	inch	mm	inch	mm	inch	inch	inch	mm	inch	mm	inch	mm
746HFFW _ 1/4 X 1/4	1/4	6.35	7/16-20	0.39	10	0.17	4.4	1/2	9/16	0.49	12.40	0.27	7.1	0.90	22.86
746HFFW _ 3/8 X 3/8	3/8	9.52	9/16-18	0.41	10.5	0.27	7.1	5/8	11/16	0.60	15.2	0.37	9.65	1.09	27.69
746HFFW _ 1/2 X 1/2	1/2	12.7	3/4.-16	0.46	11.9	0.38	9.9	13/16	7/8	0.73	18.5	0.38	9.7	1.19	30.23
746HFFW _ 3/4 X 3/4	3/4	19.05	1-1/16-12	0.46	11.9	0.61	15.5	1-1/16	1-1/4	1.04	26.4	0.44	11.2	1.32	33.53
746HFFW _ 1 X 1	1	25.4	1-5/16-12	0.55	14.2	0.84	21.5	1-3/8	1-1/2	1.36	34.5	0.61	15.7	1.61	40.9

HAM-LET METAL HOSES COMPONENTS | FITTINGS

PRESWAGED TUBE ADAPTER 739LW

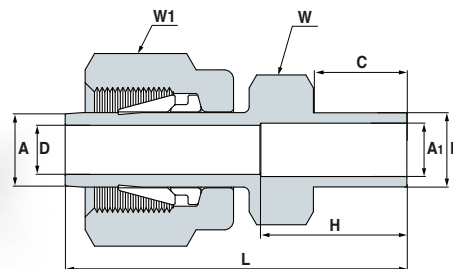
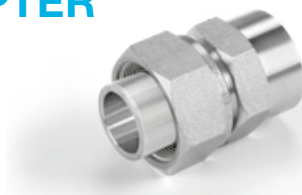

Ordering Information (INCH)	A Tube O.D		A1 Tube O.D		C		D		W Hex. Flat	F		H		L		W1 Hex. Flat
	inch	mm	inch	mm	inch	mm	inch	mm	inch	inch	mm	inch	mm	inch	mm	inch
739LW _ 1/4 X 3/8 PRSW	1/4	6.35	3/8	9.52	0.47	11.9	0.17	4.2	5/8	0.62	15.8	0.38	9.7	1.35	34.3	9/16
739LW _ 3/8 X 3/8 PRSW	3/8	9.52	3/8	9.52	0.47	11.9	0.28	7.11	5/8	0.62	15.8	0.38	9.7	1.42	36.7	11/16
739LW _ 1/2 X 1/2 PRSW	1/2	12.7	1/2	12.7	0.47	11.9	0.39	9.91	13/16	0.75	19.05	0.5	12.7	1.67	42.42	7/8
739LW _ 3/4 X 3/4 PRSW	3/4	19.05	3/4	19.05	0.47	11.9	0.59	15	1-1/16	1.05	26.7	0.56	14.2	1.73	43.94	1-1/8
739LW _ 1 X 3/4 PRSW	1	25.4	3/4	19.05	0.74	11.9	0.8	20.3	1-1/16	1.05	26.7	0.56	14.2	2.12	54	1-1/2
739LW _ 1 X 1 PRSW	1	25.4	1	25.4	0.74	11.9	0.8	20.3	1-3/8	1.36	34.5	0.76	19.2	2.33	59.2	1-1/2

Ordering Information (METRIC)	A Tube O.D		A1 Tube O.D	C	D	W Hex. Flat		F	H	L	W1 Hex. Flat	
	mm	inch	inch	mm	mm	inch	MM	mm	mm	mm	mm	inch
739LW _ 6MMX 1/4 PRSW	6	1/4	10.4	4	1/2	-	11.2	7.9	31.7	14	-	-
739LW _ 8MM X 1/4 PRSW	8	1/4	10.4	5.6	-	14	11.2	7.9	35.3	16	-	-
739LW _ 10MMX 3/8 PRSW	10	3/8	11.9	7.1	5/8	-	15.8	9.7	36	-	3/4	-
739LW _ 12MM X 1/2 PRSW	12	1/2	11.9	8.8	13/16	-	19.05	12.7	42.5	22	-	-
739LW _ 18MM X 3/4 PRSW	18	3/4	11.9	13.9	-	27	26.7	14.2	46.2	30	-	-
739LW _ 25MM X 1 PRSW	25	1	11.9	19.8	-	35	34.5	19.2	58.7	-	1 1/2	-

HAM-LET PTFE HOSES

COMPONENTS





PTFE HOSES COMPONENTS | FITTINGS

LET-LOK® 130 LHT

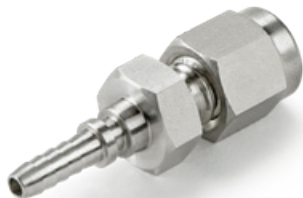
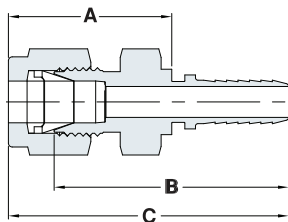

Ordering Information	Hose I.D.	Tube Size	B		C		A	
			inch	mm	inch	mm	inch	mm
INCH								
130LHT _ 1/8 X 1/8 SP	1/8	1/8	1.19	30.30	1.57	39.90	0.90	22.90
130LHT _ 1/4 X 1/4 SP	1/4	1/4	1.44	36.70	1.73	44.05	1.02	25.80
130LHT _ 3/8 X 3/8 SP	3/8	3/8	1.70	43.20	1.99	50.60	1.09	27.80
130LHT _ 1/2 X 1/2 SP	1/2	1/2	1.94	49.30	2.34	59.50	1.23	31.20
130LHT _ 3/4 X 1/2 SP	1/2	3/4	2.03	51.60	2.43	61.80	1.32	33.45
130LHT _ 3/4 X 3/4 SP	3/4	3/4	2.25	57.15	2.65	67.30	1.28	32.40
130LHT _ 1 X 1 SP	1	1	2.54	64.50	3.02	76.70	1.47	37.45
130LHT _ 1-1/2 X 1-1/2 SP	1-1/2	1-1/2	3.92	99.60	4.99	126.80	2.47	62.75
METRIC								
130LHT _ 3MM X 1/8 SP	1/8	3mm	1.18	30.00	1.45	36.90	0.90	22.90
130LHT _ 6MM X 1/4 SP	1/4	6mm	1.44	36.70	1.74	44.10	1.02	25.80
130LHT _ 8MM X 1/4 SP	1/4	8mm	1.45	36.90	1.75	44.40	1.03	26.15
130LHT _ 10MM X 3/8 SP	3/8	10mm	1.71	43.50	2.01	51.10	1.12	28.40
130LHT _ 12MM X 1/2 SP	1/2	12mm	1.94	49.30	2.34	59.40	1.22	31.10
130LHT _ 18MM X 3/4 SP	3/4	18mm	2.25	57.15	2.65	67.25	1.16	29.35
130LHT _ 25MM X 1 SP	1	25mm	2.70	68.55	3.19	80.90	1.64	41.65
130LHT _ 38MM X 1-1/2 SP	1-1/2	38mm	4.02	102.00	5.10	129.60	2.83	71.90

TUBE ADAPTER 130 LTT

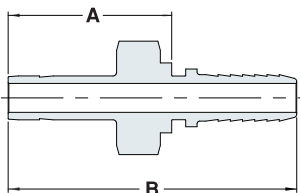

Ordering Information	Hose I.D.	Tube Size	B		A	
			inch	mm	inch	mm
INCH						
130LTT _ 1/8 X 1/8 SP	1/8	1/8	1.37	34.80	0.82	20.80
130LTT _ 1/4 X 1/8 SP	1/8	1/4	1.51	38.30	0.96	24.30
130LTT _ 1/4 X 1/4 SP	1/4	1/4	1.65	41.90	0.93	23.63
130LTT _ 3/8 X 3/8 SP	3/8	3/8	1.93	48.90	1.03	26.20
130LTT _ 3/8 X 1/2 SP	1/2	3/8	2.17	55.10	1.06	26.80
130LTT _ 1/2 X 1/2 SP	1/2	1/2	2.38	60.55	1.27	32.25
130LTT _ 3/4 X 1/2 SP	1/2	3/4	2.52	64.00	1.41	35.70
130LTT _ 3/4 X 3/4 SP	3/4	3/4	2.76	70.00	1.38	35.10
130LTT _ 5/8 X 5/8 SP	5/8	5/8	2.54	64.60	1.39	35.25
130LTT _ 3/4 X 1 SP	1	3/4	2.95	75.00	1.41	35.75
130LTT _ 1 X 3/4 SP	3/4	1	3.08	78.30	1.71	43.40
130LTT _ 1 X 1 SP	1	1	3.28	83.30	1.73	44.05
130LTT _ 1-1/2 X 1-1/2 SP	1-1/2	1-1/2	5.35	136.00	3.08	78.30
METRIC						
130LTT _ 3MM X 1/8 SP	1/8	3mm	1.37	34.80	0.82	20.80
130LTT _ 6MM X 1/4 SP	1/4	6mm	1.68	42.70	0.96	24.45
130LTT _ 8MM X 1/4 SP	1/4	8mm	1.71	43.50	0.99	25.25
130LTT _ 10MM X 3/8 SP	3/8	10mm	1.89	48.00	0.90	22.75
130LTT _ 12MM X 1/2 SP	1/2	12mm	2.39	60.70	1.28	32.40
130LTT _ 18MM X 1/2 SP	1/2	18mm	2.52	64.00	1.41	35.70
130LTT _ 18MM X 3/4 SP	3/4	18mm	2.76	70.00	1.38	35.10
130LTT _ 25MM X 1 SP	1	25mm	3.44	87.30	1.91	48.50
130LTT _ 38MM X 1-1/2 SP	1 1/2	38mm	5.35	136.00	3.08	78.30

PTFE HOSES COMPONENTS | FITTINGS

MALE NPT

130 HMTH

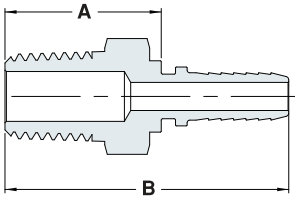

Ordering Information	Hose I.D.	Male NPT	B		A	
			inch	mm	inch	mm
130HMTH _ 1/8 X 1/8 SP	1/8	1/8	1.25	31.70	0.70	17.70
130HMTH _ 1/4 X 1/4 SP	1/4	1/4	1.60	40.55	0.88	22.40
130HMTH _ 1/4 X 3/8 SP	3/8	1/4	1.81	45.90	0.91	23.15
130HMTH _ 1/4 X 1/2 SP	1/2	1/4	2.04	51.80	0.93	23.50
130HMTH _ 3/8 X 3/8 SP	3/8	3/8	1.80	45.60	0.90	22.87
130HMTH _ 3/8 X 1/2 SP	1/2	3/8	2.04	51.80	0.93	23.50
130HMTH _ 1/2 X 1/2 SP	1/2	1/2	2.22	56.45	1.11	28.15
130HMTH _ 1/2 X 3/4 SP	3/4	1/2	2.51	63.65	1.13	28.70
130HMTH _ 3/4 X 3/4 SP	3/4	3/4	2.51	63.65	1.13	28.70
130HMTH _ 3/4 X 1 SP	1	3/4	2.72	69.10	1.18	29.85
130HMTH _ 1 X 1 SP	1	1	2.92	74.05	1.37	34.80
130HMTH _ 1-1/2 X 1-1/2 SP	1-1/2	1-1/2	4.24	107.80	1.97	50.10
130HMTH _ 2 X 2 SP	2	2	4.73	120.25	2.02	51.30

MALE BSP-P

130 HMTHG

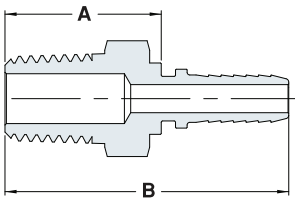

Ordering Information	Hose I.D.	Male BSPP	B		A	
			inch	mm	inch	mm
130HMTHG _ 1/8 X 1/8 SP	1/8	1/8	1.20	30.60	0.65	16.60
130HMTHG _ 1/4 X 1/4 SP	1/4	1/4	1.63	41.40	0.92	23.25
130HMTHG _ 1/4 X 3/8 SP	3/8	1/4	1.80	45.80	0.91	23.10
130HMTHG _ 1/4 X 1/2 SP	1/2	1/4	2.06	52.30	0.94	24.00
130HMTHG _ 3/8 X 3/8 SP	3/8	3/8	1.78	45.10	0.88	22.40
130HMTHG _ 3/8 X 1/2 SP	1/2	3/8	2.03	51.60	0.93	23.50
130HMTHG _ 1/2 X 1/2 SP	1/2	1/2	2.15	54.70	1.04	26.50

PTFE HOSES COMPONENTS | FITTINGS

FEMALE NPT

130 HFTH

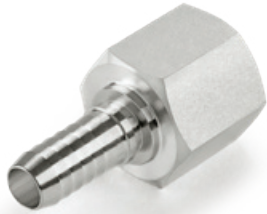
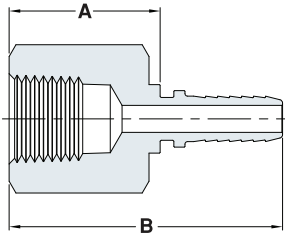

Ordering Information	Hose I.D.	Female NPT	B		A	
			inch	mm	inch	mm
130HFTH _ 1/8 X 1/8 SP	1/8	1/8	1.18	30.00	0.63	16.00
130HFTH _ 1/4 X 1/4 SP	1/4	1/4	1.60	40.55	0.88	22.40
130HFTH _ 1/4 X 3/8 SP	3/8	1/4	1.78	45.30	0.89	22.55
130HFTH _ 3/8 X 3/8 SP	3/8	3/8	1.78	45.30	0.89	22.55
130HFTH _ 1/2 X 1/2 SP	1/2	1/2	2.23	56.70	1.12	28.40
130HFTH _ 3/4 X 3/4 SP	3/4	3/4	2.51	63.80	1.14	28.90
130HFTH _ 1 X 1 SP	1	1	3.08	78.20	1.55	39.25
130HFTH _ 1-1/2 X 1-1/2 SP	1-1/2	1-1/2	3.87	98.25	1.60	40.55

FEMALE BSP-P

130 HFTHG

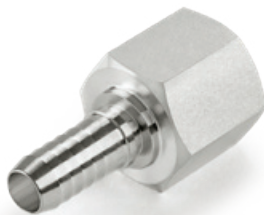
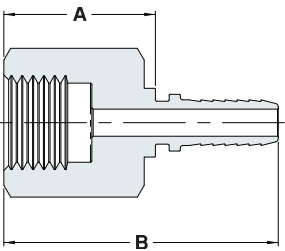

Ordering Information	Hose I.D.	Female BSPP	B		A	
			inch	mm	inch	mm
130HFTHG _ 1/8 X 1/8 SP	1/8	1/8	1.28	32.40	0.72	18.40
130HFTHG _ 1/4 X 1/4 SP	1/4	1/4	1.60	40.55	0.88	22.40
130HFTHG _ 3/8 X 3/8 SP	3/8	3/8	1.72	43.75	0.83	21.00
130HFTHG _ 1/2 X 1/2 SP	1/2	1/2	2.25	57.10	1.13	28.80
130HFTHG _ 3/4 X 3/4 SP	3/4	3/4	2.54	64.60	1.17	29.70
130HFTHG _ 1 X 1 SP	1	1	3.08	78.20	1.54	39.00

PTFE HOSES COMPONENTS | FITTINGS

BUTT WELD ADAPTER

130 HBWTH

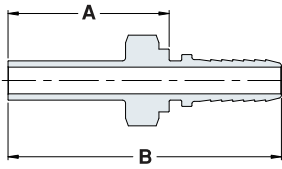

Ordering Information	Hose I.D.	Tube Size	B		A	
			inch	mm	inch	mm
130HBWTH _ 1/4 X 1/4	1/4	1/4	1.74	44.20	1.02	25.95
130HBWTH _ 3/8 X 3/8	3/8	3/8	1.95	49.50	1.05	26.75
130HBWTH _ 1/2 X 1/2	1/2	1/2	2.22	56.45	1.11	28.15
130HBWTH _ 1/2 X 3/4	1/2	3/4	2.22	56.45	1.11	28.15
130HBWTH _ 3/4 X 3/4	3/4	3/4	2.51	63.65	1.13	28.70
130HBWTH _ 1 X 3/4	1	3/4	2.73	69.30	1.18	30.05
130HBWTH _ 1 X 1	1	1	2.73	69.30	1.18	30.05
130HBWTH _ 1-1/2 X 1-1/2	1-1/2	1-1/2	3.96	100.70	2.27	57.70

FEMALE FACE SEAL

SWIVEL

130 FHC

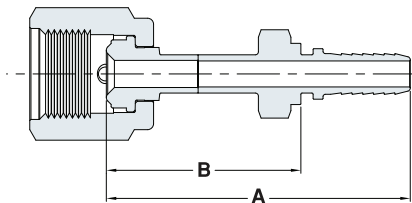

Ordering Information	Hose I.D.	Face Seal	B		A	
			inch	mm	inch	mm
130FHC _ 1/4 x 1/4	1/4	1/4	1.27	32.23	1.98	50.40
130FHC _ 1/2 x 1/2	1/2	1/2	1.73	43.90	2.84	72.20
130FHC _ 3/4 x 3/4	3/4	3/4	2.25	57.10	3.36	85.41
130FHC _ 1 x 3/4	1	3/4	2.32	59.05	3.87	98.30
130FHC _ 1 x 1	1	1	2.44	62.05	3.99	101.30

PTFE HOSES COMPONENTS | FITTINGS

MALE JIC 37° FLARE

130HFLTH

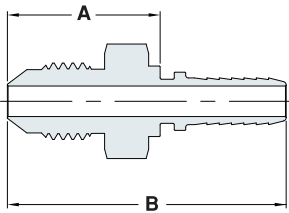

Ordering Information	Hose I.D.	Face Seal	B		A	
			inch	mm	inch	mm
130HFLTH _ 1/8 X 1/8 MALE	1/8	1/8	1.37	34.80	0.82	20.85
130HFLTH _ 1/4 X 1/4 MALE	1/4	1/4	1.58	40.15	0.86	21.90
130HFLTH _ 3/8 X 3/8 MALE	3/8	3/8	1.81	46.10	1.06	27.03
130HFLTH _ 1/2 X 1/2 MALE	1/2	1/2	2.18	55.25	1.06	26.95
130HFLTH _ 3/4 X 3/4 MALE	3/4	3/4	2.77	70.45	1.40	35.55
130HFLTH _ 1 X 1 MALE	1	1	3.08	78.20	1.53	38.95
130HFLTH _ 1-1/2X1-1/2MALE	1-1/2	1-1/2	4.19	106.35	1.92	48.65

FEMALE JIC 37° FLARE

130HFLTHF

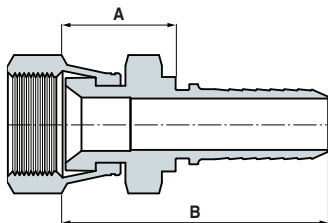

Ordering Information	Hose I.D.	Tube Size	B		A	
			inch	mm	inch	mm
130HFLTHF _ 1/8 X 1/8 FEMALE	1/8	1/8	-	-	-	-
130HFLTHF _ 1/4 X 1/4 FEMALE	1/4	1/4	1.31	33.15	0.59	14.90
130HFLTHF _ 3/8 X 3/8 FEMALE	3/8	3/8	1.58	40.20	0.69	17.45
130HFLTHF _ 1/2 X 1/2 FEMALE	1/2	1/2	1.92	48.70	0.80	20.40
130HFLTHF _ 3/4 X 3/4 FEMALE	3/4	3/4	2.23	56.60	0.85	21.70
130HFLTHF _ 1 X 1 FEMALE	1	1	2.68	68.00	1.13	28.75
130HFLTHF _ 1-1/2X1-1/2 FEMALE	1-1/2	1 -1/2	3.89	98.80	1.62	41.10

PTFE HOSES COMPONENTS | FITTINGS

MALE BSP-T

130 HMTHR

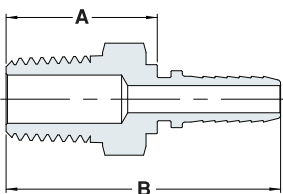

Ordering Information	Hose I.D.	Male BSPT	B		A	
			inch	mm	inch	mm
130HMTHR _ 1/8 X 1/8	1/8	1/8	1.25	31.75	0.70	17.80
130HMTHR _ 1/4 X 1/4	1/4	1/4	1.59	40.30	0.87	22.05
130HMTHR _ 3/8 X 3/8	3/8	3/8	1.77	45.05	0.88	22.30
130HMTHR _ 1/2 X 1/2	1/2	1/2	2.28	57.90	1.17	29.60
130HMTHR _ 3/4 X 3/4	3/4	3/4	2.60	66.05	1.22	31.10
130HMTHR _ 1 X 1	1	1	3.08	78.20	1.54	39.00
130HMTHR _ 1-1/2 X 1-1/2	1-1/2	1-1/2	4.24	107.70	1.97	50.00

FEMALE BSP-T

130 HFTHR

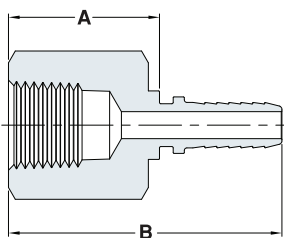

Ordering Information	Hose I.D.	Female BSPT	B		A	
			inch	mm	inch	mm
130HFTHR _ 1/8 X 1/8	1/8	1/8	1.18	29.95	0.63	16.00
130HFTHR _ 1/4 X 1/4	1/4	1/4	1.51	38.30	0.79	20.05
130HFTHR _ 3/8 X 3/8	3/8	3/8	1.74	44.30	0.85	21.55
130HFTHR _ 1/2 X 1/2	1/2	1/2	2.19	55.60	1.07	27.30
130HFTHR _ 3/4 X 3/4	3/4	3/4	2.51	63.75	1.14	28.85
130HFTHR _ 1 X 1	1	1	3.08	78.20	1.54	39.00
130HFTHR _ 1-1/2 X 1-1/2	1-1/2	1-1/2	-	-	-	-

PTFE HOSES COMPONENTS | FITTINGS

TUBE ADAPTER PRESWAGED

130LTT PRSW

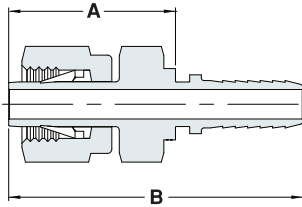

Ordering Information	Hose I.D.	Tube Size	B		A		
			inch	mm	inch	mm	
INCH							
130LTT _ 1/4X1/4PRSW SP	1/4	1/4	1.65	41.90	0.93	23.63	
130LTT _ 3/8X3/8PRSW SP	3/8	3/8	1.93	48.90	1.03	26.20	
130LTT _ 3/8X1/2PRSW SP	1/2	3/8	2.17	55.10	1.06	26.80	
130LTT _ 1/2X1/2PRSW SP	1/2	1/2	2.38	60.55	1.27	32.25	
130LTT _ 3/4X3/4PRSW SP	3/4	3/4	2.76	70.00	1.38	35.10	
130LTT _ 1"X1"PRSW SP	1	1	3.28	83.30	1.73	44.05	
METRIC							
130LTT _ 6MMX1/4PRSW SP	1/4	6mm	1.68	42.70	0.96	24.45	
130LTT _ 8MMX1/4PRSW SP	1/4	8mm	1.71	43.50	0.99	25.25	
130LTT _ 10MMX3/8PRSW SP	3/8	10mm	1.89	48.00	0.90	22.75	
130LTT _ 12MMX1/2PRSW SP	1/2	12mm	2.39	60.70	1.28	32.40	
130LTT _ 18MMX1/2PRSW SP	1/2	18mm	2.52	64.00	1.41	35.70	
130LTT _ 18MMX3/4PRSWSP	3/4	18mm	2.76	70.00	1.38	35.10	
130LTT _ 25MMX1PRSW SP	1	25mm	3.44	87.30	1.91	48.50	

CRIMP RING FOR SMOOTH PTFE CORE HOSES

THT _ CRMP

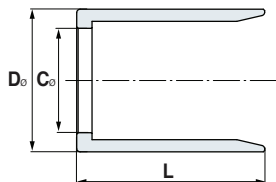

Ordering Information	L		C		D	
	inch	mm	Inch	mm	Inch	mm
THT02-CRMP-HD	0.63	16.0	0.23	5.80	0.36	9.10
THT04-CRMP-HD	0.89	22.60	0.33	8.50	0.62	15.80
THT06-CRMP-HD	0.75	19.15	0.44	11.05	0.67	17.10
THT08-CRMP-HD	1.06	27.00	0.59	15.00	0.81	20.50
THT12-CRMP-HD	1.40	35.50	0.88	22.40	1.16	29.50
THT16-CRMP-HD	1.55	39.30	1.15	29.30	1.48	37.70

PTFE HOSES COMPONENTS | FITTINGS

CRIMP RING FOR CONVOLUTED PTFE CORE HOSES

THC_CRMP

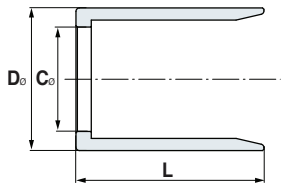

Ordering Information	L		C		D	
	inch	mm	Inch	mm	Inch	mm
THC04-CRMP-HD	0.83	21	0.42	10.8	0.73	18.5
THC06-CRMP-HD	0.91	23	0.55	13.9	0.89	22.5
THC08-CRMP-HD	1.15	29.2	0.62	15.7	1.0	25.1
THC12-CRMP-HD	1.37	34.7	0.95	24	1.36	34.6
THC16-CRMP-HD	1.57	40	1.18	30	1.65	42
THC24-CRMP-HD	2.50	63	1.74	44.3	2.17	55

HAM-LET RUBBER HOSES

COMPONENTS



RUBBER HOSES COMPONENTS | FITTINGS

LET-LOK® TUBE FITTINGS

130 LHPO / 130 LHPOP

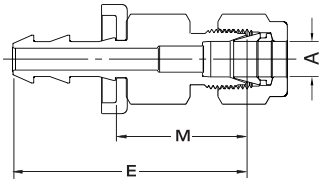

Ordering Information	Hose I.D.	A Tube O.D.	E		M	
			inch	mm	inch	mm
PO INCH						
130LHPO _ 1/4 X 1/4	1/4	1/4	1.97	42.67	1.14	23.92
130LHPO _ 3/8 X 3/8	3/8	3/8	2.11	46.22	1.17	24.52
130LHPO _ 1/2 X 1/2	1/2	1/2	2.47	52.58	1.37	26.68
130LHPO _ 3/4 X 3/4	3/4	3/4	2.96	65.05	1.32	23.3
130LHPO _ 1 X 1	1	1	3.01	64.36	1.6	28.36
PO INCH TO MM						
130LHPO _ 1/4 X 6MM	1/4	6mm	1.97	10.64	1.14	6.16
130LHPO _ 1/4 X 8MM	1/4	8mm	1.97	10.64	1.14	6.16
130LHPO _ 3/8 X 8MM	3/8	8mm	-	-	-	-
130LHPO _ 3/8 X 10MM	3/8	10mm	-	-	-	-
130LHPO _ 1/2 X 12MM	1/2	12mm	2.47	13.34	1.45	7.83
130LHPO _ 3/4 X 18MM	3/4	18mm	-	-	-	-
130LHPO _ 1 X 25MM	1	25mm	-	-	-	-

Ordering Information	Hose I.D.	A Tube O.D.	E		M	
			inch	mm	inch	mm
POP INCH						
130LHPOP _ 1/4 X 1/4	1/4	1/4	1.43	36.20	0.70	17.70
130LHPOP _ 3/8 X 3/4	3/8	3/4	2.38	60.50	0.97	24.60
130LHPOP _ 3/4 X 3/4	3/4	3/4	2.39	60.65	0.97	24.65

UNIONS

132 PO

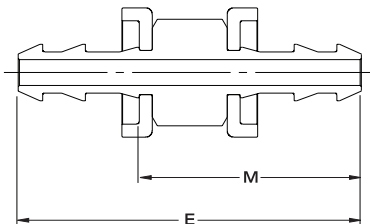

Ordering Information	Hose I.D.	Hose I.D.	E		M	
			inch	mm	inch	mm
PO						
132PO _ 1/4 X 1/4	1/4	1/4	2.07	52.6	1.33	33.85
132PO _ 3/8 X 3/8	3/8	3/8	2.25	57.2	1.4	35.5
132PO _ 1/2 X 1/2	1/2	1/2	2.61	66.3	1.59	40.4
132PO _ 3/4 X 3/4	3/4	3/4	3.82	97.1	2.18	55.35
132PO _ 1 X 1	1	1	3.57	90.8	2.16	54.8

RUBBER HOSES COMPONENTS | FITTINGS

MALE PIPE THREADS

130 HMPO / 130 HMPOP

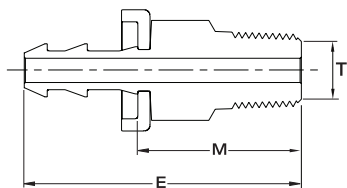

Ordering Information	Hose I.D.	T NPT	E		M		
			inch	mm	inch	mm	
PO NPT							
130HMPO _ 1/4 X 1/4	1/4	1/4	1.68	42.7	0.94	23.95	
130HMPO _ 1/4 X 3/8	1/4	3/8	1.69	43.0	0.95	24.25	
130HMPO _ 3/8 X 1/4	3/8	1/4	1.80	45.7	0.94	24.0	
130HMPO _ 3/8 X 3/8	3/8	3/8	1.80	45.7	0.94	24.0	
130HMPO _ 3/8 X 1/2	3/8	1/2	2.02	51.2	1.16	29.5	
130HMPO _ 1/2 X 3/8	1/2	3/8	2.02	51.34	1.0	25.44	
130HMPO _ 1/2 X 1/2	1/2	1/2	2.19	55.6	1.17	29.7	
130HMPO _ 1/2 X 3/4	1/2	3/4	2.21	56.14	1.19	30.24	
130HMPO _ 3/4 X 1/2	3/4	1/2	2.81	71.4	1.17	29.65	
130HMPO _ 3/4 X 3/4	3/4	3/4	2.81	71.4	1.17	29.65	
130HMPO _ 1 X 1	1	1	2.99	76.06	1.58	40.06	
POP NPT							
130HMPOP _ 1/4X1/4	1/4	1/4	1.57	40.1	0.82	21.6	
130HMPOP _ 1/4X1/2	1/4	1/2	1.9	48.3	1.17	29.8	
130HMPOP _ 3/8X1/4	3/8	1/4	1.78	45.0	0.88	22.75	
130HMPOP _ 3/8X3/8	3/8	3/8	1.78	45.3	0.9	23.05	
130HMPOP _ 1/2X3/8	1/2	3/8	1.93	49.0	0.9	22.9	
130HMPOP _ 1/2X1/2	1/2	1/2	2.18	55.5	1.16	29.4	
130HMPOP _ 1/2X3/4	1/2	3/4	2.23	56.6	1.2	30.5	
130HMPOP _ 3/4X1/2	3/4	1/2	2.61	66.4	1.2	30.5	
130HMPOP _ 3/4X3/4	3/4	3/4	2.61	66.4	1.2	30.5	
130HMPOP _ 1 X 1	1	1	3.06	78.0	1.66	42.1	

MALE PIPE THREADS

130 HMRPO / 130 HMRPOP

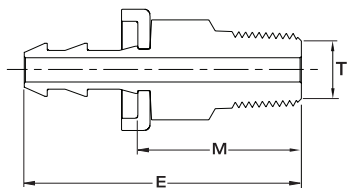

Ordering Information	Hose I.D.	T ISO	E		M		
			inch	mm	inch	mm	
BSP TAPERED							
130HMRPO _ 3/8 X 3/8	3/8	3/8	1.8	45.7	0.94	24.0	
130HMRPO _ 1/2 X 1/2	1/2	1/2	2.19	55.6	1.17	29.7	
130HMRPO _ 3/4 X 1/2	3/4	1/2	2.81	71.4	1.17	29.65	
130HMRPO _ 3/4 X 3/4	3/4	3/4	2.81	71.4	1.17	29.65	

RUBBER HOSES COMPONENTS | FITTINGS

TUBE ADAPTER

131 PO / 131 POP

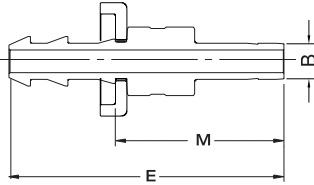

Ordering Information	Hose I.D.	B Tube O.D.	E		M	
			inch	mm	inch	mm
PO INCH						
131PO _ 1/4 X 1/4	1/4	1/4	1.91	48.5	1.17	29.75
131PO _ 3/8 X 1/4	3/8	1/4	1.95	49.6	1.10	27.9
131PO _ 3/8 X 3/8	3/8	3/8	2.02	51.3	1.17	29.6
131PO _ 1/2 X 3/8	1/2	3/8	2.25	57.14	1.23	31.24
131PO _ 1/2 X 1/2	1/2	1/2	2.47	62.74	1.45	36.84
131PO _ 3/4 X 1/2	3/4	1/2	3.04	77.1	1.39	35.35
131PO _ 3/4 X 3/4	3/4	3/4	3.14	79.8	1.50	38.05
131PO _ 1 X 3/4	1	3/4	3.06	77.7	1.64	41.7
131PO _ 1 X 1	1	1	3.39	86.0	1.97	50.0
PO MM						
131PO _ 1/4 X 8MM	1/4	8mm	1.52	49.6	1.21	30.85
131PO _ 3/8 X 8 MM	3/8	8mm	2.0	50.9	1.15	29.2
131PO _ 3/8 X 12MM	3/8	12mm	2.24	56.9	1.39	35.2
131PO _ 1/2 X 12MM	1/2	12mm	2.47	62.74	1.45	36.48
131PO _ 3/4 X 18MM	3/4	18mm	3.14	79.8	1.50	38.05
POP INCH						
131POP _ 1/4 X 1/4	1/4	1/4	1.89	48.0	1.17	29.65
131POP _ 1/4 X 3/16	1/4	3/16	1.63	41.5	0.91	23.15

NOTE: For other end connection types and sizes please contact your local UCT representative.

PTFE HOSES STANDARD CONFIGURATIONS

The following configurations are available as standard.

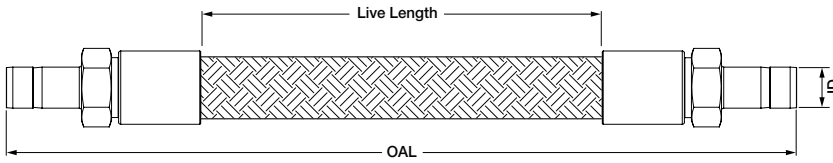

Tube Adapter To Tube Adapter End Connection

Inside Diameter	Overall Length OAL	Ordering Description	Max. Working Pressure	Dimensions			Item number
				Live Length (L)	Minimum Inside Diameter	Maximum Outside Dimension	
inch	inch (mm)		Psi (bar)	inch (mm)			
1/4	6.00 (15.3)	THT04-TS1/4TS1/4-6-ST	3200 (221)	2.4 (59.9)	0.16 (4.2)	0.56 (14.3)	3904870
	12.0 (30.5)	THT04-TS1/4TS1/4-12-ST	3200 (221)	8.4 (212.3)	0.16 (4.2)	0.56 (14.3)	3903349
	18.0 (45.7)	THT04-TS1/4TS1/4-18-ST	3200 (221)	14.4 (364.7)	0.16 (4.2)	0.56 (14.3)	3904791
	24.0 (61.0)	THT04-TS1/4TS1/4-24-ST	3200 (221)	20.4 (517.1)	0.16 (4.2)	0.56 (14.3)	3903095
	36.0 (91.4)	THT04-TS1/4TS1/4-36-ST	3200 (221)	32.4 (821.9)	0.16 (4.2)	0.56 (14.3)	3903044
	48.0 (122)	THT04-TS1/4TS1/4-48-ST	3200 (221)	44.4 (1126.7)	0.16 (4.2)	0.56 (14.3)	3903292
	60.0 (152.4)	THT04-TS1/4TS1/4-60-ST	3200 (221)	56.4 (1431.5)	0.16 (4.2)	0.56 (14.3)	3903191
	72.0 (182.88)	THT04-TS1/4TS1/4-72-ST	3200 (221)	68.4 (1736.3)	0.16 (4.2)	0.56 (14.3)	3903387
120.0 (304.8)	THT04-TS1/4TS1/4-120-ST	3200 (221)	113.4 (2955.5)	0.16 (4.2)	0.56 (14.3)	3903096	
3/8	12.0 (30.5)	THT06-TS3/8TS3/8-12-ST	2500 (172)	8.4 (214.2)	0.28 (7.1)	0.63 (15.9)	3908923
	18.0 (45.7)	THT06-TS3/8TS3/8-18-ST	2500 (172)	14.4 (366.6)	0.28 (7.1)	0.63 (15.9)	3908924
	24.0 (61.0)	THT06-TS3/8TS3/8-24-ST	2500 (172)	20.4 (519.0)	0.28 (7.1)	0.63 (15.9)	3908925
	36.0 (91.4)	THT06-TS3/8TS3/8-36-ST	2500 (172)	32.4 (823.8)	0.28 (7.1)	0.63 (15.9)	3908926
	48.0 (122)	THT06-TS3/8TS3/8-48-ST	2500 (172)	44.4 (1128.6)	0.28 (7.1)	0.63 (15.9)	3908927
	60.0 (152.4)	THT06-TS3/8TS3/8-60-ST	2500 (172)	56.4 (1433.4)	0.28 (7.1)	0.63 (15.9)	3908928
	72.0 (182.88)	THT06-TS3/8TS3/8-72-ST	2500 (172)	68.4 (1738.2)	0.28 (7.1)	0.63 (15.9)	3908929
1/2	12.0 (30.5)	THT08-TS1/2TS1/2-12-ST	2000 (138)	7.3 (186.4)	0.38 (9.5)	0.88 (22.2)	3903755
	18.0 (45.7)	THT08-TS1/2TS1/2-18-ST	2000 (138)	13.3 (338.8)	0.38 (9.5)	0.88 (22.2)	3904063
	24.0 (61.0)	THT08-TS1/2TS1/2-24-ST	2000 (138)	19.3 (491.2)	0.38 (9.5)	0.88 (22.2)	3908930
	36.0 (91.4)	THT08-TS1/2TS1/2-36-ST	2000 (138)	31.3 (796)	0.38 (9.5)	0.88 (22.2)	3903128
	48.0 (122)	THT08-TS1/2TS1/2-48-ST	2000 (138)	43.3 (1100.8)	0.38 (9.5)	0.88 (22.2)	3903754
	60.0 (152.4)	THT08-TS1/2TS1/2-60-ST	2000 (138)	55.3(1405.6)	0.38 (9.5)	0.88 (22.2)	3904307
	72.0 (182.88)	THT08-TS1/2TS1/2-72-ST	2000 (138)	67.3 (1710.4)	0.38 (9.5)	0.88 (22.2)	3907222
	120.0 (304.8)	THT08-TS1/2TS1/2-120-ST	2000 (138)	115.3 (2929.6)	0.38 (9.5)	0.88 (22.2)	3908931
3/4	24.0 (61.0)	THT12-TS3/4TS3/4-24-ST	1800 (124)	18.4 (468.4)	0.59 (15.0)	1.06 (27.0)	3908877
	36.0 (91.4)	THT12-TS3/4TS3/4-36-ST	1800 (124)	30.4 (773.2)	0.59 (15.0)	1.06 (27.0)	3904164
	48.0 (122)	THT12-TS3/4TS3/4-48-ST	1800 (124)	42.4 (1078.0)	0.59 (15.0)	1.06 (27.0)	3905027
mm	inch (mm)			inch (mm)			
6	12.0 (30.5)	THT04-TS6MTS6M-12-ST	3200 (221)	8.3 (210.7)	0.16 (4.0)	0.56 (14.2)	3903169
	24.0 (61.0)	THT04-TS6MTS6M-24-ST	3200 (221)	20.3 (515.5)	0.16 (4.0)	0.56 (14.2)	3903171
	36.0 (91.4)	THT04-TS6MTS6M-36-ST	3200 (221)	32.3 (820.3)	0.16 (4.0)	0.56 (14.2)	3903170
12	24.0 (61.0)	THT08-TS12MTS12M-24-ST	2000 (138)	19.3 (490.8)	0.38 (9.5)	0.87 (22.0)	3908878
	36.0 (91.4)	THT08-TS12MTS12M-36-ST	2000 (138)	31.3 (795.6)	0.38 (9.5)	0.87 (22.0)	3908932